



We put people first at ELORA.
The satisfaction of our customers and the well-being of our employees are our highest asset.

1220-L...

ROLLER TOOL CABINET SUPER CADDY

01

- 1220-L7 with 7 drawers, 1220-L8 with 8 drawers
- solid metal sheet pattern, ELORA-yellow (RAL 1006)
- corrosion- and scratch-resistant powder-coating
- shelf space on the top made of ABS plastic with 7 storage compartments for small parts and rim on all sides
- 200 kg shelf load capacity due to strengthened top cover
- solid handlebar, mounting possible on both sides
- sides and back panel with Euro-Perforation 10 x 38 mm (hole square 10 x 10 mm, hole centre-hole centre 38 x38 mm) for mounting accessory hooks, trays, waste basket, can holder, paper roll holder, cable drum
- central locking system with cylinder lock and 2 keys
- loading capacity of each drawer 40 kg
- each drawer has a safety locking system and is 100% extractable
- drawer with ball bearing guide rails
- drawer internal measurements W 573 x D 410 mm
- drawers ELORA-black powder-coated (RAL 9005)
- can be individually divided with separators or equipped with ELORA-OMS modules
- total loading capacity 300 kg
- broad gauge running gear with 4 Ø 125 mm full rubber, smooth running castors, 2 swivel castors with double break function (tangential and axial)
- dividers for drawers separately available
- delivery without tools and accessories
- suitable assortments: WS and OMS
- **other drawer types and special colours on request**

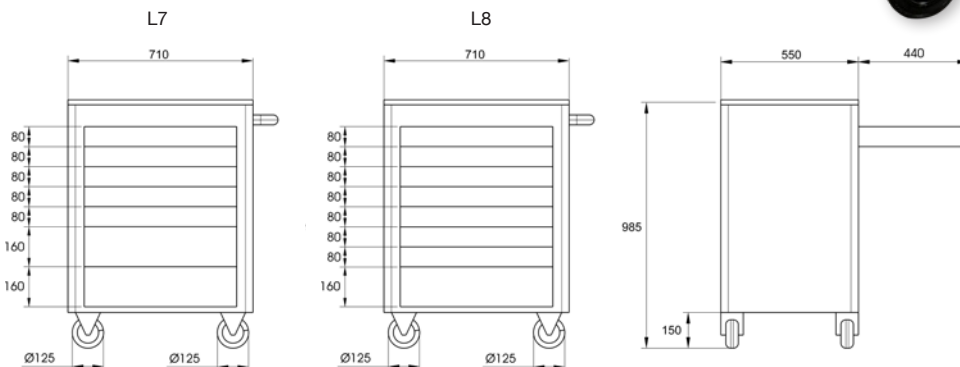

Code	Number	Height mm	Width mm	Depth mm	Loading Capacity kg	Pieces	Weight/g
1220000006000	1220-L7	977	705	545	300	1	78000
1220000006008	1220-L8	977	705	545	300	1	78000

1225-L7

ROLLER TOOL CABINET TOOLJET

01

- 7 drawers
- solid metal sheet pattern with solid sub construction, ELORA-yellow (RAL 1006)
- corrosion- and scratch-resistant powder-coating
- shelf space on the top made of ABS plastic with 7 storage compartments for small parts and rim on all sides
- 200 kg shelf load capacity due to strengthened top cover
- solid ergonomic steel reinforced handlebar, mounting possible on both sides
- sides and recessed back panel with Euro-Perforation 10 x 38 mm (hole square 10 x 10 mm, hole centre-hole centre 38 x 38 mm) for mounting accessory hooks, trays, waste basket, can holder, paper roll holder, cable drum
- central locking system with cylinder lock and individual drawer lock system (if one drawer is open it is not possible to open another one)
- loading capacity of each drawer 40 kg
- each drawer has a safety locking system and is 100% extractable
- drawer with ball bearing guide rails
- drawer internal measurements W 573 x D 410 mm
- drawers ELORA-black powder-coated (RAL 9005)
- can be individually divided with separators or equipped with ELORA-OMS modules
- total loading capacity 450 kg
- broad gauge running gear with 4 Ø 125 mm full rubber, smooth running castors, 2 swivel castors with double break function (tangential and axial)
- delivery without tools and accessories
- suitable assortments: WS and OMS
- dividers for drawers separately available
- **other drawer types and special colours on request**

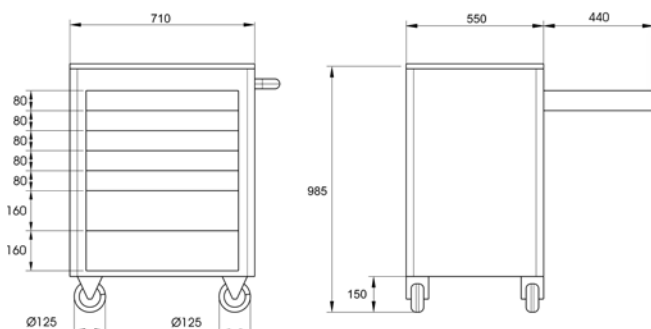

Code	Number	Height mm	Width mm	Depth mm	Loading Capacity kg	Pieces	Weight/g
1225000006000	1225-L7	980	705	545	450	1	82000

1110-..., 1220-...

ACCESSORIES ROLLER TOOL CABINET SUPER CADDY AND TOOLJET

- for use at back and side panels of roller the tool cabinets ELORA-No. 1220-L7, 1220-L8 and 1225-L7
- at the side and rear panel of the roller tool cabinet accessories can be mounted by using the Euro-perforation 10 x 38 mm (square 10 x 10 mm, hole centre to hole centre 38 x 38 mm)
- holder made of steel sheet, 1,25 mm thick
- 1110 KH made from plastic



1220-KS

1220-PH

1220-PK

1220-DH

1220-KT

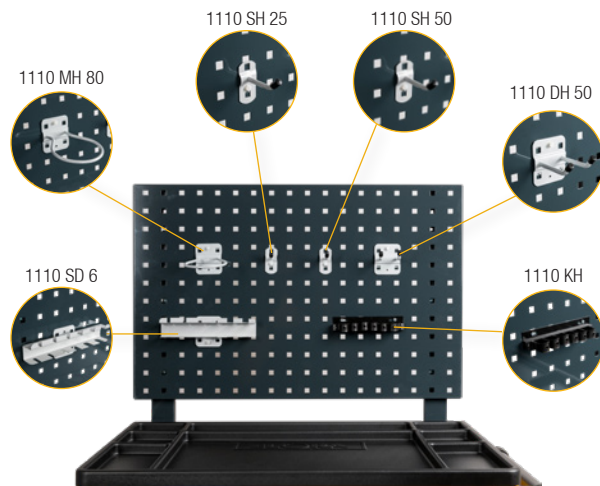

Code	Number	Productinformation	Dimensions WxHxD	Pieces	Weight/g
1110900002025	1110 SH 25	Tool Holder	-	1	20
1110900002050	1110 SH 50	Tool Holder	-	1	24
1110900012050	1110 DH 50	Tool Holder, double hook	-	1	62
1110900002080	1110 MH 80	Machine Holder	-	1	84
1110900002006	1110 SD 6	Screwdriver Holder	-	1	169
1110900002000	1110 KH	Terminal Holder, plastic	-	1	16
1220800016000	1220-PK	Waste Basket	300x300x250	1	2860
1220800026000	1220-PH	Paper Roll Holder	300x200x150	1	1430
1220800036000	1220-DH	Can Holder	300x200x150	1	2110
1220802206000	1220-AS220	Tray	220x60x80	1	540
1220803006000	1220-AS300	Tray	300x60x80	1	720
1220800046000	1220-KT	Cable Roller 10 m	-	1	2000
1220800056000	1220-RW	Rear Panel	455x700	1	6800
1220800066000	1220-KS	Edge protector	-	1	350

1220-TBS..., 1220-FTS...

SEPARATING PLATES

- drawer division for ELORA-Super Caddy ELORA-No. 1220-L7, 1220-L8 and ELORA ToolJet, ELORA-No. 1225-L7 for division of the drawers
- zinc-plated metal sheet

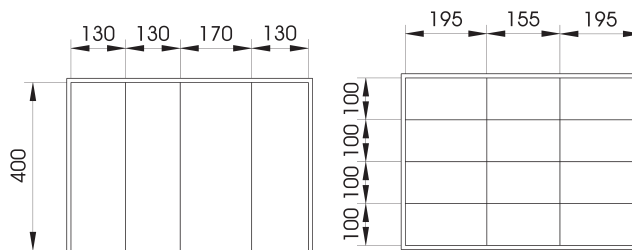

Code	Number	Productinformation	Height mm	Pieces	Weight/g
1220800606000	1220-TBS60	Separating Plate, 3 pcs.	60	1	200
1220801006000	1220-TBS100	Separating Plate, 3 pcs.	100	1	350
1220800806000	1220-FTS80	Separator Set	80	1	1120
1220801606000	1220-FTS160	Separator Set	160	1	3035

1200-RM 18

ANTI SLIP MAT

- for drawers in tool cabinets and work benches
- Length: 2m



Code	Number	Width mm	Pieces	Weight/g
1200004752000	1200-RM 18	475	1	650

1210-L...

ROLLER TOOL CABINET BUDDY

- 7 drawers
- solid metal sheet pattern, corrosion- and scratch-resistant powder-coating
- shelf space on the top made of ABS plastic with 5 storage compartments for small parts and rim on all sides
- solid handlebar, mounting possible on both sides
- up to 6 different accessories mountable in the recessed side wall e.g. storage foldable tray for small parts ELORA No. 1210-ES, screwdriver tray for 8 screwdrivers ELORA No. 1210-SD
- 2 can holder are included
- central locking system with 2 keys
- loading capacity of each drawer 20 kg respectively 30 kg for the two lower drawers
- each drawer has a safety locking system and is 100% extractable
- drawer with ball bearing guide rails
- drawer internal measurements W 570 x D 410 mm
- drawers ELORA-black powder-coated
- can be Individually equipped with ELORA OMS modules
- total loading capacity 300 kg
- broad gauge running gear with 4 Ø 125 mm full rubber, smooth running casters, 2 swivel castors with double break function (tangential and axial)
- delivery without tools and accessories
- suitable assortments: WS and OMS



1210-L7B

1210-L7R

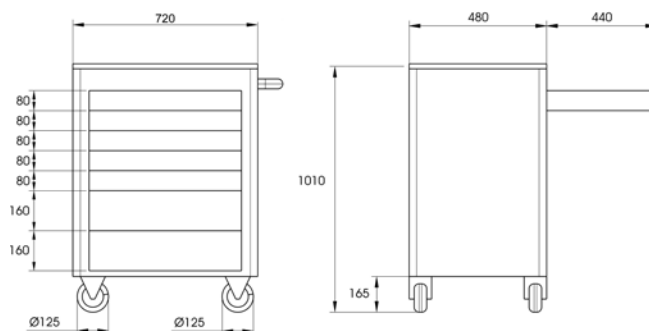

Code	Number	Height mm	Width mm	Depth mm	Loading Capacity kg	Pieces	Weight/g
1210000006000	1210-L7	1010	710	470	300	1	67000
1210000016000	1210-L7R	1010	710	470	300	1	67000
1210000026000	1210-L7B	1010	710	470	300	1	67000

1210-...

ACCESSORIES ROLLER TOOL CABINET BUDDY

- ▶ for ELORA roller tool cabinet Buddy; ELORA-No. 1210-L...
- ▶ up to 6 different accessories mountable in the recessed side wall e.g. storage foldable tray for small parts ELORA No. 1210-ES, screwdriver tray for 8 screwdrivers ELORA No. 1210-SD
- ▶ the wooden panel ELORA No. 1210-PL fits exactly onto the ABS-storage shelf and make it a plane working surface



Code	Number	Productinformation	Pieces	Weight/g
1210800001001	1210-ES	Foldable Tray	1	550
1210800001002	1210-SD	Screwdriver Tray	1	410
1210800001003	1210-PL	Wooden Panel	1	4000

1210-ET...

DRAWER SEPERATOR FOR ROLLER TOOL CABINET BUDDY

- ▶ for division of the drawers
- ▶ metal sheet

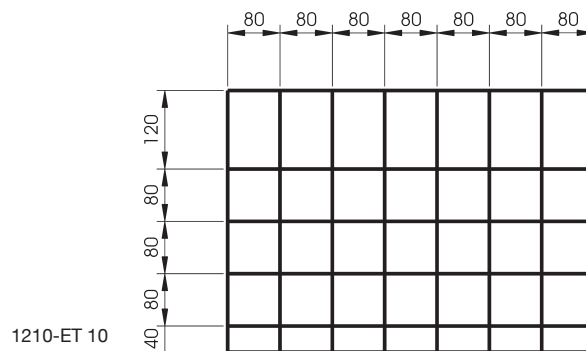
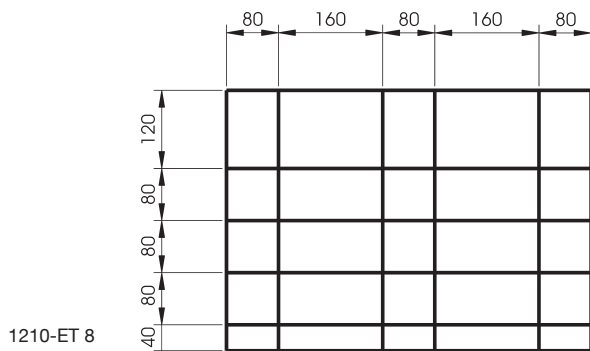
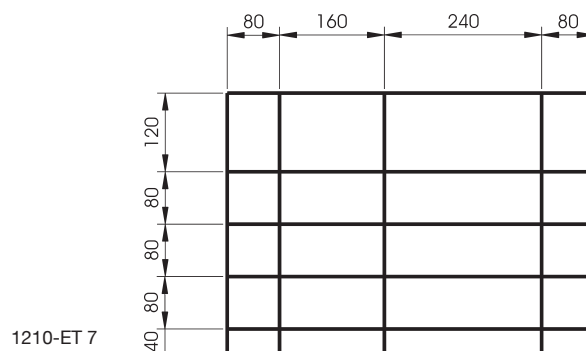
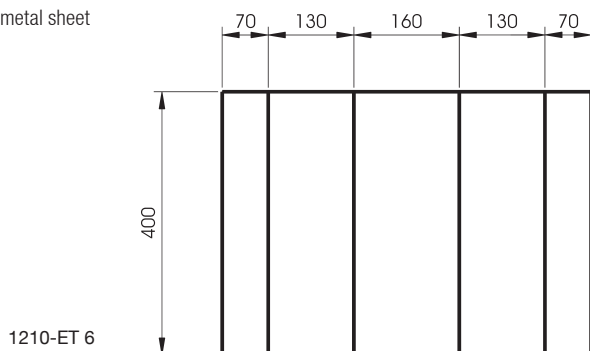

Code	Number	Productinformation	Height mm	Pieces	Weight/g
1210800061000	1210-ET 6	6 pcs.	50	1	1108
1210800071000	1210-ET 7	7 pcs.	50	1	1086
1210800081000	1210-ET 8	8 pcs.	50	1	1212
1210800101000	1210-ET 10	10 pcs.	50	1	1566

1811-L

WHEELED WORK BENCH

- scratch resistant, powder coated, ELORA-yellow (RAL 1006), door/drawers black (RAL 9006)
- laminated beech wood (Multiplex) work bench board
- drawers with ball-bearing guide rails, full telescopic drawer slide
- 6 drawers with roller bearing, internal dimensions of drawers: width 573 x Depth 410
- individual separation using length- and cross dividers, resp. using ELORA OMS-modules
- central locking with mutual drawer locking
- 40kg load capacity per drawer
- separate door locking, with one shelf (storage space with separately lockable door and one shelf)
- front side panels with square Euro holes
- stable handle
- 2 fixed and 2 braked swivel castors
- total load capacity 450 kg
- suitable assortments: all OMS-Modules

01

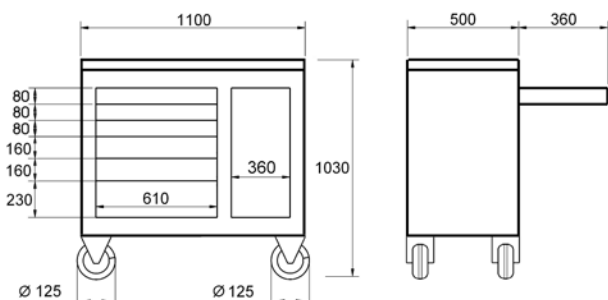

Code	Number	Width mm	Height mm	Depth mm	Pieces	Weight/g
1811500006000	1811-L	1200	1025	505	1	93000

1810-L

WORKBENCH

- massive beech wood bench top, bolt like laminated, oiled, 40 mm
- static load: 300 kg (distributed load)
- floor level adjustment screws
- drawers 100% extractable
- drawers internal measurements W 433 x D 538 mm
- load each drawer: ca. 35 kg
- central locking system for the drawers
- 2 locks per workbench keyed alike, main key available
- drawers can be divided with separator set ELORA-No. 1810-ET
- storage space with shelf and door
- door lockable by 2 cylinder locks, simultaneous locking
- powder-coated, body ELORA-yellow (RAL1006, door/drawers ELORA-black RAL9005)



Code	Number	Height mm	Width mm	Depth mm	Loading Capacity kg	Pieces	Weight/g
1810500006000	1810-L	840	1200	600	300	1	93000
1810500007000	1810-ET	60	-	-	-	1	800

1227-L
CABINET

- completely welded steel sheet construction
- 2 doors, with 4 height-adjustable shelves
- load capacity 50 kg per shelf
- doors strengthened and 3-point safety lock
- rotary handle with cylinder lock
- powder coated, ELORA-yellow (RAL 1006) doors black (RAL 9005)



Code	Number	Width mm	Height mm	Depth mm	Pieces	Weight/g
1227000006000	1227-L	950	1900	500	1	83000

1100L
TOOL CABINET

- 2 doors, with 2 drawers
- lockable with cylinder lock
- powder coated, ELORA-yellow (RAL 1006), doors black (RAL 9005)
- stable steel sheet version
- suitable assortments: all OMS-Modules



Code	Number	Width mm	Height mm	Depth mm	suitable assortments	Pieces	Weight/g
1100520001000	1100L	690	1000	290	WS-1 to 5	1	26000

1815

WORK TABLE, FOLDABLE

- ▶ for mobile use, foldable to measurement H 140, W 1000, D 700 mm
- ▶ strong, multiple glued beech wood working surface
- ▶ rack made of steel tube, scratch-resistant ELORA yellow lacquered



Code	Number	Height mm	Width mm	Depth mm	Loading Capacity kg	Pieces	Weight/g
1815010001000	1815	820	1000	700	500	1	26000

800L/810L

CANTILEVER TOOL BOX WITH 5 TRAYS

- ▶ blue lacquered, to be locked with padlock ELORA-No. 256
- ▶ heavy gauge sheet steel



Code+	Number	Width mm	Height mm	Depth mm	suitable assortments	Pieces	Weight/g
0800520031000	800L	430	200	200	WS-1, 9	1	4300
0810510031000	810L	530	200	200	WS-1, 2, 3, 4, 8, 9, 10	1	5200

803L/813L

CANTILEVER TOOL BOX WITH 3 TRAYS

- ▶ blue lacquered, to be locked with padlock ELORA-No. 256
- ▶ heavy gauge sheet steel



Code	Number	Width mm	Height mm	Depth mm	suitable assortments	Pieces	Weight/g
0803510036000	803L	430	150	195	WS-1, 9	1	3300
0813510036000	813L	530	150	195	WS-1, 9	1	3600

256

PADLOCK

- ▶ for cantilever tool box ELORA-No.800L, 803L, 810L and 813L
- ▶ with steel bow 29 mm, incl. 2 keys
- ▶ Brass



Code	Number	Width mm	Pieces	Weight/g
0256000000000	256	43,8	1	80

1380-L
HARD PROTECTIVE CASE

- variable dividable floor shell
- removable cover board with 15 tool pockets
- removable tool board with 22 tool pockets on the front and back
- document compartment in the lid (A4 format)
- 2 lockable clip locks made of metal
- hinge cover
- robust aluminium frame with protection for the sharp edges
- trolley case made of dent proof black ABS material
- **delivery without tools**



Code	Number	Internal measurements WxDxH mm	External measurements WxDxH mm	max. bearing load	suitable assortments	Pieces	Weight/g
1380000000000	1380-L	460x315x169	490x365x188	25	WS-4, 6, 8, 9, 10	1	5000

1381-L
HARD PROTECTIVE TROLLEY CASE

- mobile case with telescopic handle and 2 free running rollers
- variable dividable floor shell
- removable cover board with 15 tool pockets
- removable tool board with 23 tool pockets on the front and back
- document compartment in the lid (A4 format)
- 2 lockable clip locks made of metal and additional combination lock
- hinge cover
- robust aluminium frame with protection for the sharp edges
- trolley case made of dent proof black ABS material
- **delivery without tools**



Code	Number	Internal measurements WxDxH mm	External measurements WxDxH mm	max. bearing load	Volume l	suitable assortments	Pieces	Weight/g
1381000000000	1381-L	485x375x200	515x440x225	30	36	WS-4, 6, 8, 9, 10	1	6280

1386-L

TECHNICIANS NOTEBOOK TOOL BAG

- padded lap-top compartment (17") and additional document compartment (A4 format)
- removable tool board with 8 pockets on the front and 2 rows elastic hangers on the back
- 2 small and 5 big pockets on the inside
- key ring holder
- front side 90 ° foldable
- on each side big attached pocket with hook and loop fastener
- splash proofed bottom
- adjustable strap with shoulder cushion quick fastener
- handle double fixable
- made of tear-proofed black nylon
- **delivery without tools and accessories**



Code	Number	Internal measurements WxDxH mm	External measurements WxDxH mm	max. bearing load	Pieces	Weight/g
1386000000000	1386-L	440x320x180	450x340x200	12	1	2380

1385-L

INSTALLATION TOOL BAG

- robust tool bag with moisture repellent bottom
- solid metal handle with padded grip
- removable cover and padded carrying strap
- outside 5 compartments with hook and loop fastener, fixation for water level
- inside 10 pockets an 8 hangers
- made of tear-proofed durable black nylon
- **delivery without tools**



Code	Number	Internal measurements WxDxH mm	External measurements WxDxH mm	max. bearing load	suitable assortments	Pieces	Weight/g
1385000000000	1385-L	400x190x240	450x250x270	12	WS-6, 9, 10	1	2820

OMS-47

MODULE-AUTOMOTIVE-TIRE AND BRAKE ASSORTMENT

- for ELORA-roller tool cabinets
- black, with yellow signal colour
- oil and grease resistant
- chemical resistant
- Width: 41,0 cm, Depth: 57,3 cm
- hard foam insert

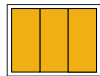
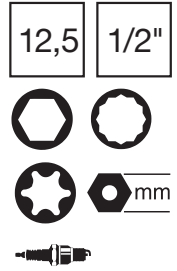

Code	Number	Contents	Pieces	Weight/g
0000414701000	OMS-47	Combination Spanner with Ring Ratchet, reversible 204-J 8, 10, 12, 13, 17, 19 mm Double-Ended Ring Spanner for outside TORX®-Screws 119TXE- 6×8, 10×12, 14×18, 20×24 mm Open Ring Spanner 121-10×11 mm Adjustable Wrench 60-12MB Spark Plug Socket 1/2" 771-LTZ 16, 18, 20,8 mm Socket Converter 770-L14, 1/2" 3/8" Impact Socket 1/2" 790LTP-17, 19, 21 mm Torque Wrench with Vernier Scale 2179-60 10-60 Nm, 2179-200 40-200 Nm Engineer's Hammer, German Pattern 1665-500 Feeler Gauge 188-13M Tyre Lever 165-300, 165-500 Brush for Brake Service 293BS Seal Flat Scraper 290-1	1	6565
0000414707000	OMS-47L	empty module	1	180

OMS-50

MODULE-SPANNER SET

- for ELORA-roller tool cabinets
- black, with yellow signal colour
- oil and grease resistant
- chemical resistant
- Width: 41,0 cm, Depth: 57,3 cm
- hard foam insert

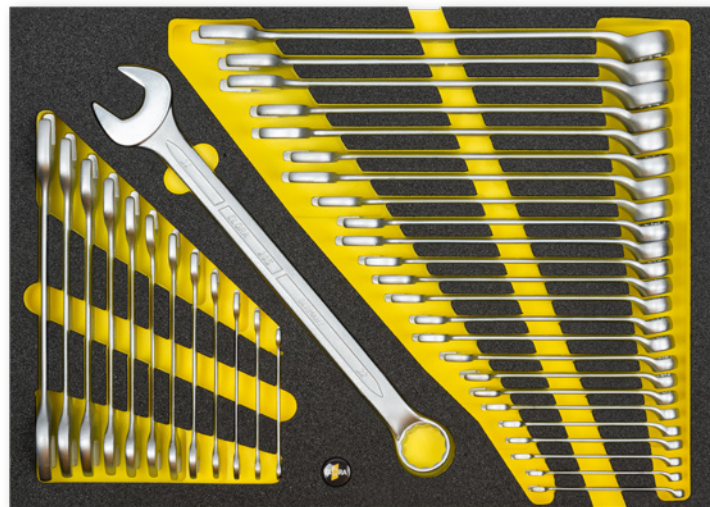

Code	Number	Contents	Pieces	Weight/g
0000415001000	OMS-50	Combination Spanners, cranked 205- 6, 7, 8, 9, 10, 11, 12, 13, 14, 15, 16, 17, 18, 19, 20, 21, 22, 23, 24, 25, 26, 27, 28, 30, 32 mm Double Open-Ended Spanners DIN 3110 100- 6×7, 8×9, 10×11, 12×13, 14×15, 16×17, 18×19, 20×22, 21×23, 24×27, 25×28, 30×32 mm	1	8010
0000415007000	OMS-50L	empty module	1	160

OMS-15

MODULE-DOUBLE OPEN ENDED SPANNER

- ▶ for ELORA-roller tool cabinets
- ▶ black, with yellow signal colour
- ▶ oil and grease resistant
- ▶ chemical resistant
- ▶ Width: 41,0 cm, Depth: 18,9 cm
- ▶ hard foam insert

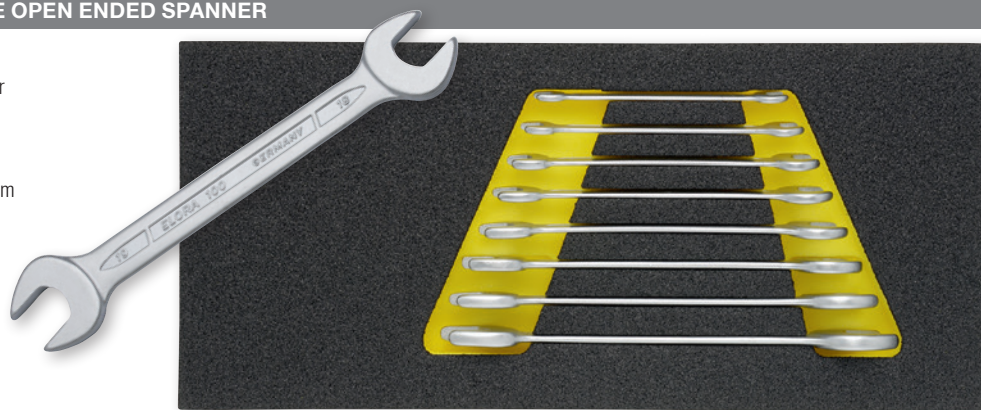

mm

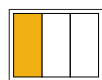

Code	Number	Contents	Pieces	Weight/g
0000411501000	OMS-15	Double Open-Ended Spanners DIN 3110 100- 6×7, 8×9, 10×11, 12×13, 14×15, 16×17, 18×19, 20×22 mm	1	900
0000411507000	OMS-15L	empty module	1	80

OMS-1

MODULE-COMBINATION SPANNERS, CRANKED

- ▶ for ELORA-roller tool cabinets
- ▶ black, with yellow signal colour
- ▶ oil and grease resistant
- ▶ chemical resistant
- ▶ Width: 41,0 cm, Depth: 18,9 cm
- ▶ hard foam insert

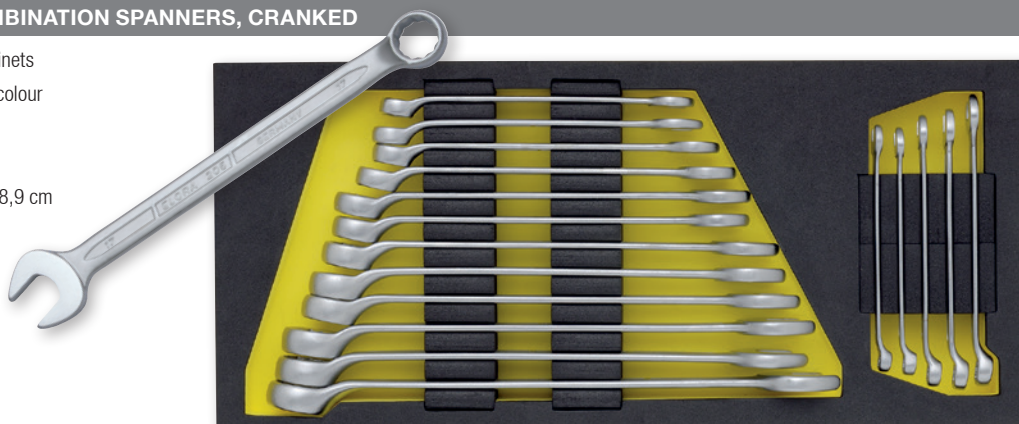

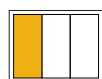
 mm

Code	Number	Contents	Pieces	Weight/g
0000410101000	OMS-1	Combination Spanners, cranked 205- 6, 7, 8, 9, 10, 11, 12, 13, 14, 15, 16, 17, 18, 19, 20, 21, 22 mm	1	1990
0000410107000	OMS-1L	empty module	1	70

OMS-51

MODULE-SPANNER SET

- ▶ for ELORA-roller tool cabinets
- ▶ black, with yellow signal colour
- ▶ oil and grease resistant
- ▶ chemical resistant
- ▶ Width: 41,0 cm, Depth: 57,3 cm
- ▶ hard foam insert

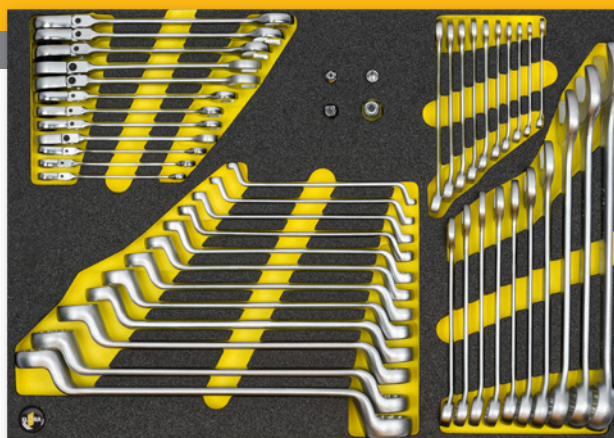

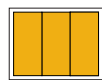
 mm

Code	Number	Contents	Pieces	Weight/g
0000415101000	OMS-51	Combination Spanners, bent 203- 6, 7, 8, 9, 10, 11, 12, 13, 14, 15, 16, 17, 18, 19, 21, 22, 24, 27, 30, 32, mm Double-Ended Ring Spanners, DIN 838 110- 6×7, 8×9, 10×11, 12×13, 14×15, 16×17, 18×19, 20×22, 21×23, 24×27, 25×28, 30×32 mm Combination Spanner with Joint-Ring Ratchet 204R- 8, 9, 10, 11, 12, 13, 14, 15, 16, 17, 18, 19 mm Adapter Drives for bits 1/4", 3/8", 1/2" und 1/4" Bit-Adaptor 118- 1, 2, 3, 4	1	8100
0000415107000	OMS-51L	empty module	1	160

OMS-9

MODULE-COMBINATION SPANNER, BENT

- for ELORA-roller tool cabinets
- black, with yellow signal colour
- oil and grease resistant
- chemical resistant
- Width: 41,0 cm, Depth: 18,9 cm
- hard foam insert

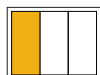
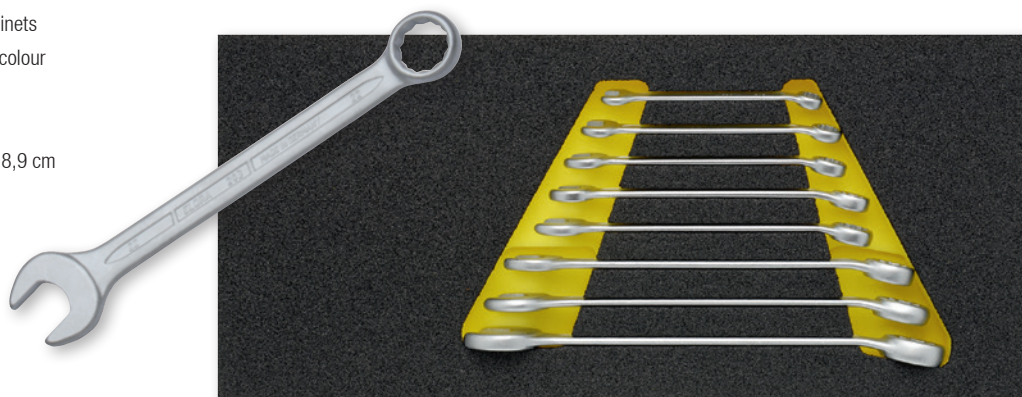

Code	Number	Contents	Pieces	Weight/g
0000410901000	OMS-9	Combination Spanners, bent 203- 8, 10, 11, 13, 14, 17, 19, 22 mm	1	690
0000410907000	OMS-9L	empty module	1	80

OMS-22

MODULE-COMBINATION SPANNER, BENT

- for ELORA-roller tool cabinets
- black, with yellow signal colour
- oil and grease resistant
- chemical resistant
- Width: 41,0 cm, Depth: 18,9 cm
- hard foam insert



Code	Number	Contents	Pieces	Weight/g
0000412201000	OMS-22	Combination Spanners, bent 203- 24, 27, 30, 32 mm	1	1820
0000412207000	OMS-22L	empty module	1	60

OMS-30

MODULE-COMBINATION SPANNER WITH RING RATCHET

- for ELORA-roller tool cabinets
- black, with yellow signal colour
- oil and grease resistant
- chemical resistant
- Width: 41,0 cm, Depth: 18,9 cm
- hard foam insert



Code	Number	Contents	Pieces	Weight/g
0000413001000	OMS-30	Combination Spanners with Ring Ratchet 204- 8, 9, 10, 12, 13, 14, 17, 19 mm Adapter Drives for bits für 1/4", 3/8", 1/2" und 1/4" Bit-Adaptor 118- 1, 2, 3, 4	1	933
0000413007000	OMS-30L	empty module	1	80

OMS-33

MODULE-COMBINATION SPANNER WITH RING RATCHET, REVERSIBLE

- for ELORA-roller tool cabinets
- black, with yellow signal colour
- oil and grease resistant
- chemical resistant
- Width: 41,0 cm, Depth: 18,9 cm
- hard foam insert

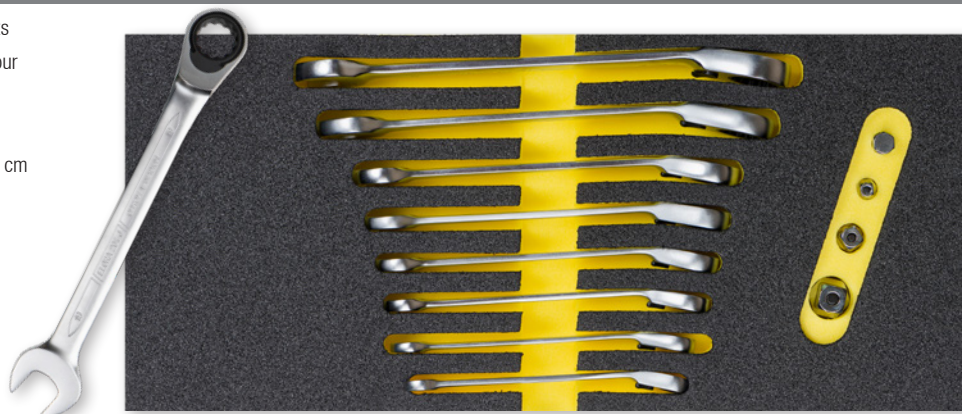

Code	Number	Contents	Pieces	Weight/g
0000413301000	OMS-33	Combination Spanner with Ring Ratchet, reversible 204J- 8, 9, 10, 12, 13, 14, 17, 19 mm Adapter Drives for bits für 1/4", 3/8", 1/2" und 1/4" Bit-Adaptor 118- 1, 2, 3, 4	1	998
0000413307000	OMS-33L	empty module	1	80

OMS-32

MODULE-COMBINATION SPANNER WITH JOINT-RING RATCHET

- for ELORA-roller tool cabinets
- black, with yellow signal colour
- oil and grease resistant
- chemical resistant
- Width: 41,0 cm, Depth: 18,9 cm
- hard foam insert



Code	Number	Contents	Pieces	Weight/g
0000413201000	OMS-32	Combination Spanner with Joint-Ring Ratchet 204R- 8, 9, 10, 12, 13, 14, 17, 19 mm Adapter Drives for bits für 1/4", 3/8", 1/2" und 1/4" Bit-Adaptor 118- 1, 2, 3, 4	1	980
0000413207000	OMS-32L	empty module	1	80

OMS-19

MODULE-DOUBLE-ENDED RING SPANNER

- for ELORA-roller tool cabinets
- black, with yellow signal colour
- oil and grease resistant
- chemical resistant
- Width: 41,0 cm, Depth: 18,9 cm
- hard foam insert

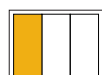
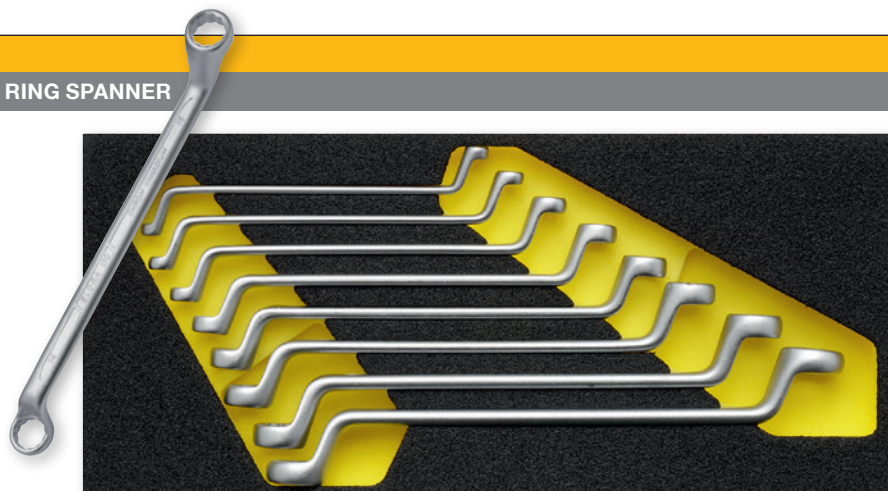

Code	Number	Contents	Pieces	Weight/g
0000411901000	OMS-19	Double-Ended Ring Spanners, DIN 838 110- 6x7, 8x9, 10x11, 12x13, 14x15, 16x17, 18x19, 20x22 mm	1	1350
0000411907000	OMS-19L	empty module	1	70

OMS-28

MODULE-RATCHET RING SPANNER

- for ELORA-roller tool cabinets
- black, with yellow signal colour
- oil and grease resistant
- chemical resistant
- Width: 41,0 cm, Depth: 18,9 cm
- hard foam insert

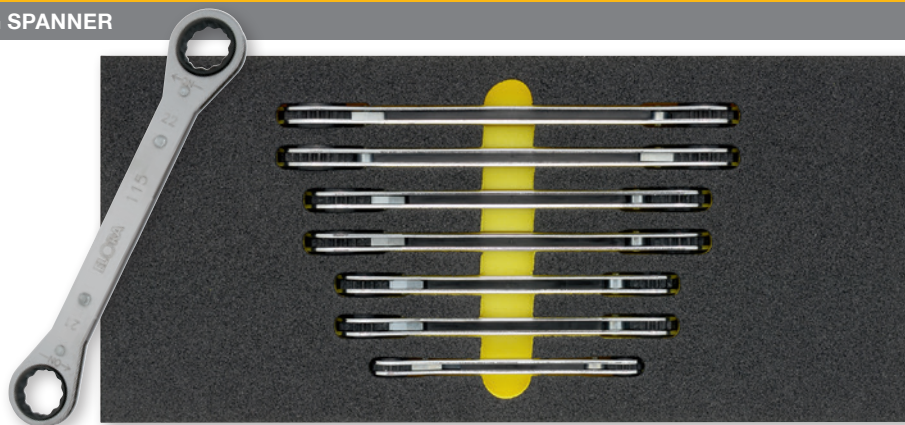

Code	Number	Contents	Pieces	Weight/g
0000412801000	OMS-28	Ratchet Ring Spanners, straight 115 - 8x9, 10x11, 12x13, 14x15, 16x17, 18x19, 21x22 mm	1	1330
0000412807000	OMS-28L	empty module	1	80

OMS-29

MODULE-RATCHET RING SPANNERS, BENT

- for ELORA-roller tool cabinets
- black, with yellow signal colour
- oil and grease resistant
- chemical resistant
- Width: 41,0 cm, Depth: 18,9 cm
- hard foam insert

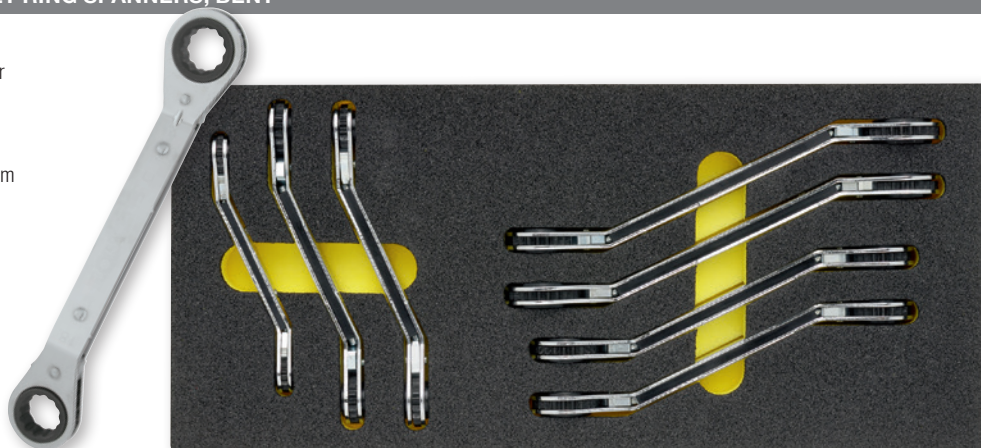
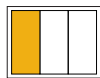

Code	Number	Contents	Pieces	Weight/g
0000412901000	OMS-29	Ratchet Ring Spanners, bent 115G - 8x9, 10x11, 12x13, 14x15, 16x17, 18x19, 21x22 mm	1	1340
0000412907000	OMS-29L	empty module	1	80

OMS-31

MODULE-FLARE NUT OPEN ENDED RING SPANNER

- for ELORA-roller tool cabinets
- black, with yellow signal colour
- oil and grease resistant
- chemical resistant
- Width: 41,0 cm, Depth: 18,9 cm
- hard foam insert

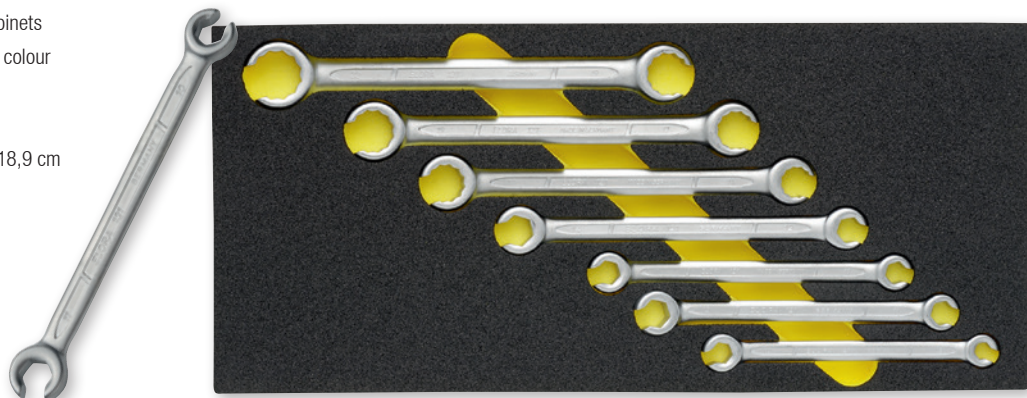
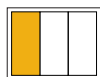

Code	Number	Contents	Pieces	Weight/g
0000413101000	OMS-31	Ended Ring Spanners for flare nuts 121 - 8x10, 10x11, 11x13, 12x14, 14x17, 17x19, 19x22 mm	1	850
0000413107000	OMS-31L	empty module	1	80

OMS-46

MODULE-SOCKET SET 1/4" AND 1/2"

- for ELORA-roller tool cabinets
- black, with yellow signal colour
- oil and grease resistant
- chemical resistant
- Width: 41,0 cm, Depth: 57,3 cm
- hard foam insert

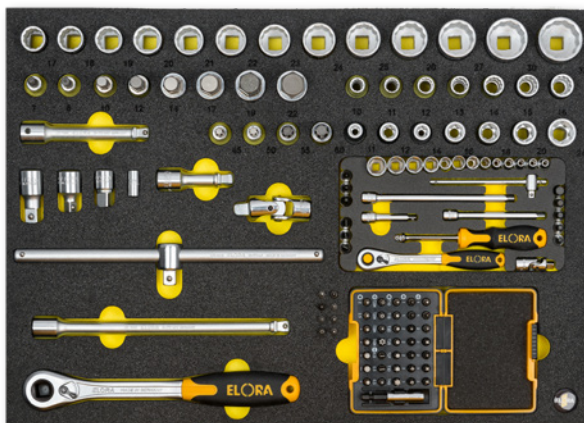

6,3 12,5

1/4" 1/2"

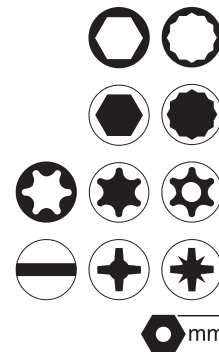

mm

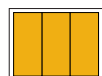

Code	Number	Contents	Pieces	Weight/g	
0000414601000	OMS-46	1440-MU Socket Set 1/4", 30 pcs. ○ ● ⊖ ⊕ Bitbox 1/4", 36 pcs. ⊖ ⊕ ⊕ ⊕ ⊕ ⊕ Screwdriver Bit 1/4" for Inside TORX® Screws ★ 3050-TX 6, 7, 8, TX 9, TX 10 Screwdriver Bit 1/4" for Inside TORX® Safety Screws ★ 3070-TTX 10, 15, 27 Socket Converter 1/4" 1450-16, 1/4" ○ 1/4" ○ Bihexagon Sockets 1/2" ○ 770-LM 10, 11, 12, 13, 14, 15, 16, 17, 18, 19, 20, 21, 22, 23, 24, 25, 26, 27, 30, 32 mm Reversible Ratchet 1/2" 770-L1D Sliding T-Bar 1/2" 770-L3	Extension Bar 1/2" 50 mm 770-L35 Extension Bar 1/2", swivelling 75 mm 770-L4V Extension Bar 1/2", swivelling 125 mm 770-L5V Extension Bar 1/2", swivelling 250 mm 770-L6V Universal Joint 1/2" 770-L7 Socket Converter 1/2" 770-L13, 3/8" ■ 1/2" ○ Socket Converter 1/2" 770-L14, 1/2" ■ 3/8" ○ Screwdriver Sockets 1/2" for inside Hexagon Screws ● 3210-IN 7, IN 8, IN 10, IN 12, IN 14, IN 17, IN 19, IN 22 Screwdriver Sockets 1/2" for Inside TORX® Screws ★ 3245-TX 45, TX 50, TX 55, TX 60 Sockets 1/2" for Outside TORX® Screws ★ 770-LTXE 11, 12, 14, 16, 18, 20, 24 mm	1	6540
0000414607000	OMS-46L	empty module	1	180	

OMS-52

MODULE-SOCKET SET, DEEP 1/4" AND 1/2"

- for ELORA-roller tool cabinets
- black, with yellow signal colour
- oil and grease resistant
- chemical resistant
- Width: 41,0 cm, Depth: 57,3 cm
- hard foam insert

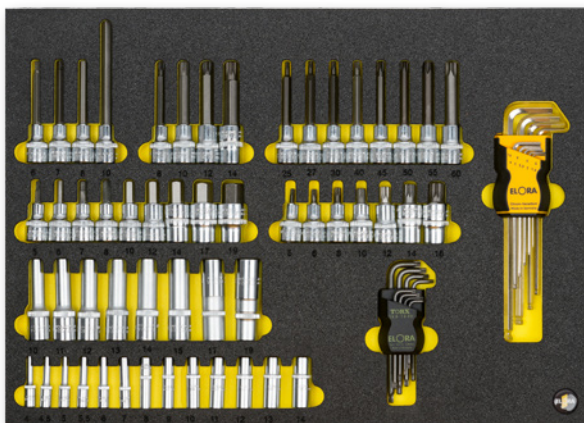

6,3 12,5

1/4" 1/2"

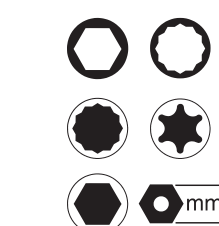

mm

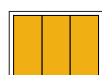

Code	Number	Contents	Pieces	Weight/g	
0000415201000	OMS-52	Hexagon Sockets, extra deep 1/4" ○ 1455-T 4, 4,5, 5, 5,5, 6, 7, 8, 9, 10, 11, 12, 13, 14 mm Hexagon Sockets, extra deep 1/2" ○ 771-LT 10, 11, 12, 13, 14, 15, 17, 19 mm Screwdriver Sockets 1/2" for inside Hexagon Screws ● 3210-IN 5, IN 6, IN 7, IN 8, IN 10, IN 12, IN 14, IN 17, IN 19 Screwdriver Sockets 1/2", long for inside Hexagon Screws ● 3210-INL 6x100, INL 7x100, INL 8x100, INL 10x140 Screwdriver Sockets 1/2", long for inside-TORX®-Screws ★ 3245-TXL 25, TXL 27, TXL 30, TXL 40, TXL 45, TXL 50, TXL 55, TXL 60	Screwdriver Sockets 1/2" for inside multi-point B & S and XZN ● 3230-XZN 5, XZN 6, XZN 8, XZN 10, XZN 12, XZN 14, XZN 16 Screwdriver Sockets 1/2", long for inside multi-point B & S and XZN ● 3230-XZNL 8x100, XZNL 10x100, XZNL 12x100, XZNL 14x100 159SKU Ball End Hexagon Key Set, extra long, 1,5-10 mm ● 162S-TXKU TORX®-Ball End Key Set, TX 9-40 ★	1	5370
0000415207000	OMS-52L	empty module	1	160	

OMS-2
MODULE-SOCKET SET 1/4"

- for ELORA-roller tool cabinets
- black, with yellow signal colour
- oil and grease resistant
- chemical resistant
- Width: 41,0 cm, Depth: 18,9 cm
- hard foam insert

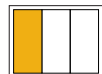
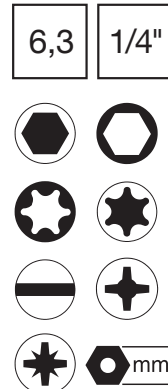

Code	Number	Contents	Pieces	Weight/g
0000410201000	OMS-2	Hexagon Sockets 1/4" ○ 1455-4, 4,5, 5, 5,5, 6, 7, 8, 9, 10,11, 12, 13, 14 mm Screwdriver Sockets for plain slotted screws ⊖ 1455-IS 0,8x4, 1,0x5,5, 1,6x8,0 mm Screwdriver Sockets for cross slotted screws ⊕ 1455-PH 1, PH 2, PH 3, PH 4 Screwdriver Sockets for cross slotted screws ⊕ 1455-PZ 1, PZ 2 Screwdriver Sockets for inside hexagon screws ● 1455-IN 3, 4, 5, 6, 8 mm Sockets for outside TORX® screws ★ 1455-TXE 4, 5, 6, 7, 8, 10,11	1 1480	Screwdriver Sockets for inside TORX® screws ★ 3243-TX 8, 10, 15, 20, 25, 27, 30,40 Reversible Ratchets 1450-1D Spinner Handle 1450-3 Sliding T-Bar 1450-4 Universal Joint 1450-8 Extension Bar 50 mm 1450-11 Extension Bar 150 mm 1450-12 Socket Converter 1/4" 1450-15, 3/8" ■ 1/4" ○ 159SKU Ball End Hexagon Key Set, extra long, 1,5-10 mm ●
0000410207000	OSM-2L	empty module	1	80

OMS-49
MODULE-SOCKET SET 3/8"

- for ELORA-roller tool cabinets
- black, with yellow signal colour
- oil and grease resistant
- chemical resistant
- Width: 41,0 cm, Depth: 37,7 cm
- hard foam insert

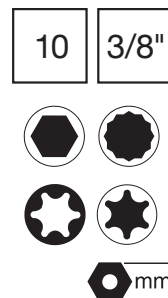
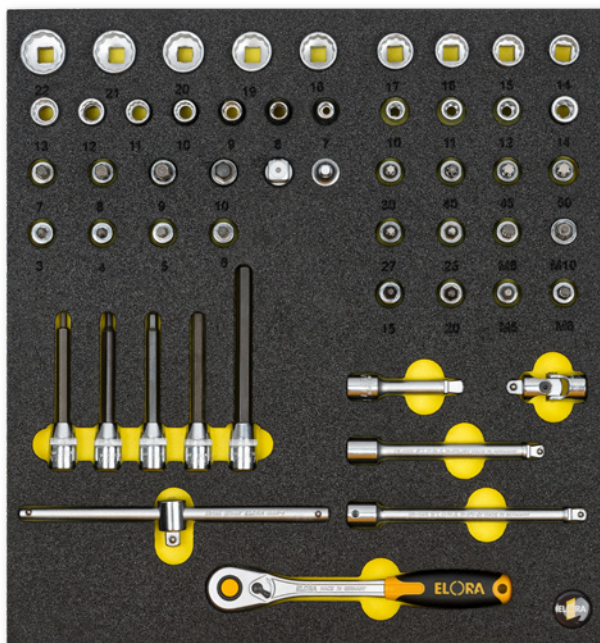

Code	Number	Contents	Pieces	Weight/g
0000414901000	OMS-49	Bi-Hexagon Sockets ○ 870- 7, 8, 9, 10, 11, 12, 13, 14, 15, 16, 17, 18, 19, 20, 21, 22 mm Screwdriver Sockets ● 3510-IN 3, 4, 5, 6, 7, 8, 9, 10 Screwdriver Sockets long for inside hexagon screws ● 3510-INL 4x100, 5x100, 6x100, 8x100, 10x130 Screwdriver Sockets for inside-TORX® screws ★ 3244-TX 15, 20, 25, 27, 30, 40, 45, 50 Screwdriver Sockets for inside multi-point B & S and XZN screws ● 3530-XZN 5, 6, 8, 10	1 3165	Screwdriver Sockets for Outside-TORX® screws ★ 870-TXE 10, 11, 12, 14 Reversible Ratchet 870-1D Sliding T-Bar 870-8 Universal Joint 870-9 Extension Bar, swivelling 50 mm 870-3V Extension Bar, swivelling 125 mm 870-35V Extension Bar, swivelling 150 mm 870-4V Socket Converter 870-10, 1/4" ■ 3/8" ○ Socket Converter 770-L14, 1/2" ■ 3/8" ○
0000414907000	OSM-49L	empty module	1	160

OMS-34/21

MODULE-SOCKET SET 3/8"

- for ELORA-roller tool cabinets
- black, with yellow signal colour
- oil and grease resistant
- chemical resistant
- Width: 41,0 cm, Depth: 18,9 cm
- hard foam insert

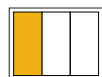
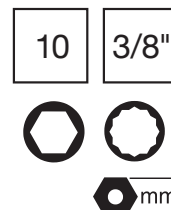

Code	Number	Contents	Pieces	Weight/g
0000413401000	OMS-34	Bi-Hexagon Sockets 870- 7, 8, 9, 10, 11, 12, 13, 14, 15, 16, 17, 18, 19, 20, 21, 22 mm ○ Reversible Ratchet 870-1D Extension Bar 125 mm 870-35 Extension Bar 250 mm 870-55 Universal Joint 870-9	1	1340
0000412101000	OMS-21	same as OMS-34, but all sockets in hexagon pattern ○	1	1340
0000412107000	OMS-21/34L	empty module	1	80

OMS-3/4

MODULE-SOCKET SET 1/2"

- for ELORA-roller tool cabinets
- black, with yellow signal colour
- oil and grease resistant
- chemical resistant
- Width: 41,0 cm, Depth: 18,9 cm
- hard foam insert

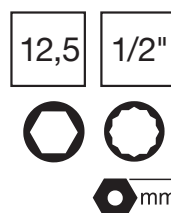
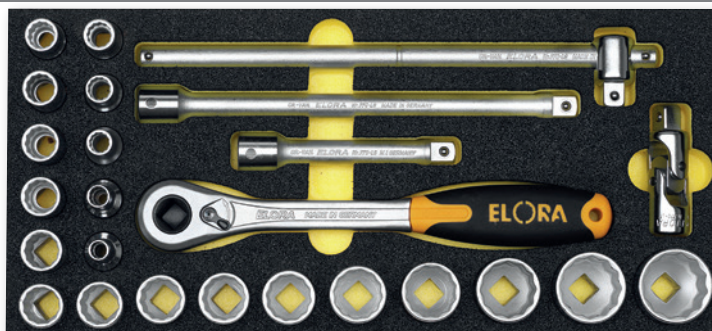

Code	Number	Contents	Pieces	Weight/g
0000410301000	OMS-3	Bi-Hexagon Sockets 770-LM 8, 9, 10, 11, 12, 13, 14, 15, 16, 17, 18, 19, 20, 21, 22, 24, 25, 27, 30, 32 mm ○ Reversible Ratchet 770-L1D Sliding T-Bar 770-L3 Extension Bar 125 mm 770-L5 Extension Bar 250 mm 770-L6 Universal Joint 770-L7	1	3420
0000410401000	OMS-4	same as OMS-3, but all sockets in hexagon pattern ○	1	3400
0000410307000	OMS-3/4L	empty module	1	80

OMS-35/25

MODULE-SOCKET SET 3/4"

- for ELORA-roller tool cabinets
- black, with yellow signal colour
- oil and grease resistant
- chemical resistant
- Width: 41,0 cm, Depth: 37,7 cm
- hard foam insert

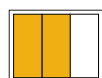
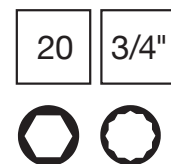
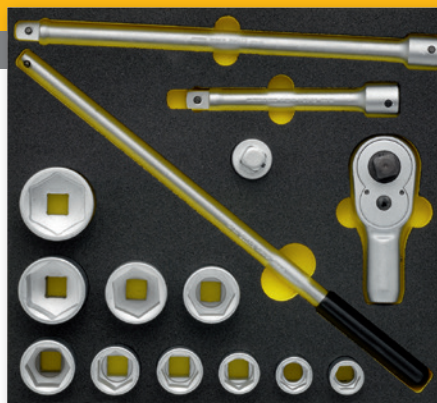

Code	Number	Contents	Pieces	Weight/g
0000413501000	OMS-35	Bi-Hexagon Sockets 770-S 22, 24, 27, 30, 32, 36, 38, 41, 46, 50 mm ○ Reversible Ratchet Head 770-S1K Extension Bar 200 mm 770-S4 Extension Bar 400 mm 770-S5 Tommy Bar 770-S7 Sliding Head 770-S13	1	9280
0000412501000	OMS-25	same as OMS-35, but all sockets in hexagon pattern ○	1	9280
0000412507000	OMS-25/35L	empty module	1	125

OMS-24

MODULE-IMPACT-SOCKET SET 1/2"

- for ELORA-roller tool cabinets
- black, with yellow signal colour
- oil and grease resistant
- chemical resistant
- Width: 41,0 cm, Depth: 18,9 cm
- hard foam insert

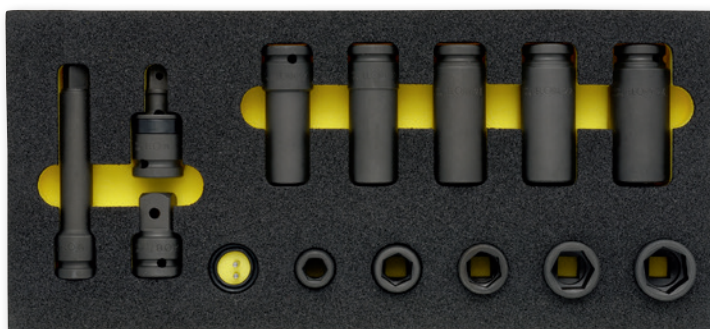

12,5

1/2"

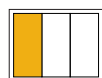

Code	Number	Contents	Pieces	Weight/g
0000412401000	OMS-24	Impact Sockets 790-13, 17, 19, 22, 24 mm ○ Impact Sockets extra deep 790LT-17, 19, 21, 22, 24 mm ○ Impact Extension Bar 7901-125 Impact Adaptor 7902-3/4, 3/4" ■ 1/2" ○ Impact Universal Joint 795 -1/2 Impact Locking pins 7903-20, 25 Impact Locking rings 7904-20, 24	1	2900
0000412407000	OMS-24L	empty module	1	80

OMS-23

MODULE-IMPACT-SOCKET SET 3/4"

- for ELORA-roller tool cabinets
- black, with yellow signal colour
- oil and grease resistant
- chemical resistant
- Width: 41,0 cm, Depth: 37,7 cm
- hard foam insert



20

3/4"

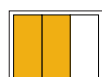

Code	Number	Contents	Pieces	Weight/g
0000412301000	OMS-23	Impact Sockets 791-24, 27, 30, 32, 36 mm ○ Impact Sockets extra deep 791LT-17, 19, 24, 27, 30, 32 mm ○ Impact Adaptor 7912-1/2, 1/2" ■ 3/4" ○ Impact Universal Joint 795 -3/4 Impact Locking pins 7913-29, 37 Impact Locking rings 7914-28, 36	1	7780
0000412307000	OMS-23L	empty module	1	125

OMS-18

MODULE-TORX®-TOOLS

- for ELORA-roller tool cabinets
- black, with yellow signal colour
- oil and grease resistant
- chemical resistant
- Width: 41,0 cm, Depth: 18,9 cm
- hard foam insert

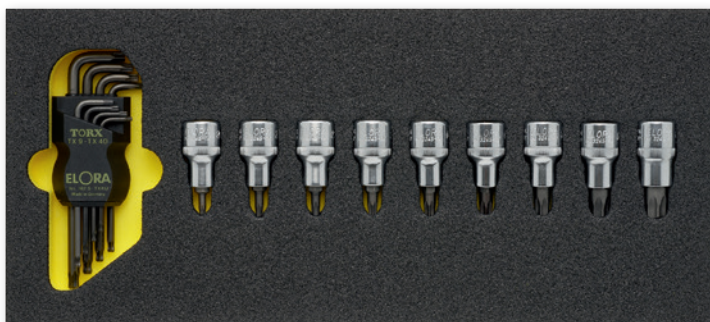

12,5

1/2"

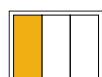

Code	Number	Contents	Pieces	Weight/g
0000411801000	OMS-18	Screwdriver Sockets for inside TORX® screws 3245 TX 20, 25, 27, 30, 40, 45, 50, 55, 60 ☉ TORX®-Ball End Key Set 162S-TXKU 9, 10, 15, 20, 25, 27, 30, 40 ☼	1	980
0000411807000	OMS-18L	empty module	1	80

OMS-26

MODULE HEXAGON KEY SET

- for ELORA-roller tool cabinets
- black, with yellow signal colour
- oil and grease resistant
- chemical resistant
- Width: 41,0 cm, Depth: 18,9 cm
- hard foam insert

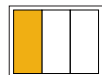
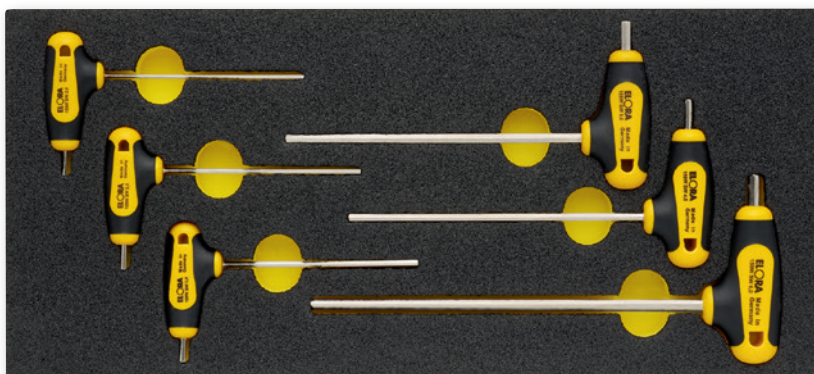

Code	Number	Contents	Pieces	Weight/g
0000412601000	OMS-26	Hexagon Key with T-Handle ● 159W-2, 2,5, 3, 4, 5, 6	1	340
0000412607000	OMS-26L	empty module	1	80

OMS-27

MODUL-TORX®-KEY SET WITH T-HANDLE

- for ELORA-roller tool cabinets
- black, with yellow signal colour
- oil and grease resistant
- chemical resistant
- Width: 41,0 cm, Depth: 18,9 cm
- hard foam insert

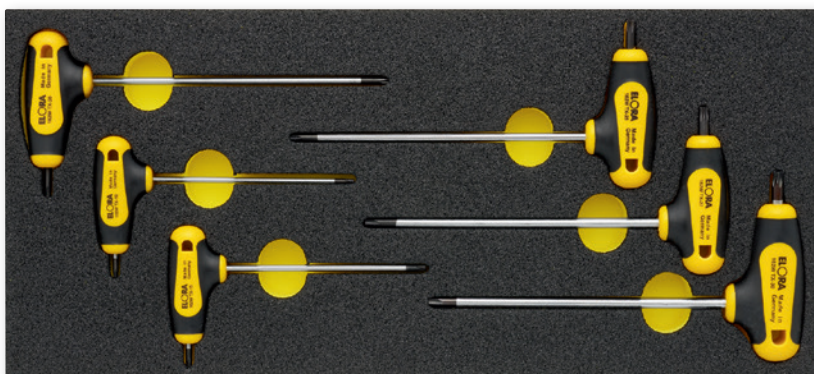

Code	Number	Contents	Pieces	Weight/g
0000412701000	OMS-27	TORX®-Key with T-Handle ★ 162WTX-10, 15, 20, 25, 27, 30	1	360
0000412707000	OMS-27L	empty module	1	80

OMS-48
MODULE-SCREWDRIVERS

- for ELORA-roller tool cabinets
- black, with yellow signal colour
- oil and grease resistant
- chemical resistant
- Width: 41,0 cm, Depth: 57,3 cm
- hard foam insert

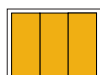
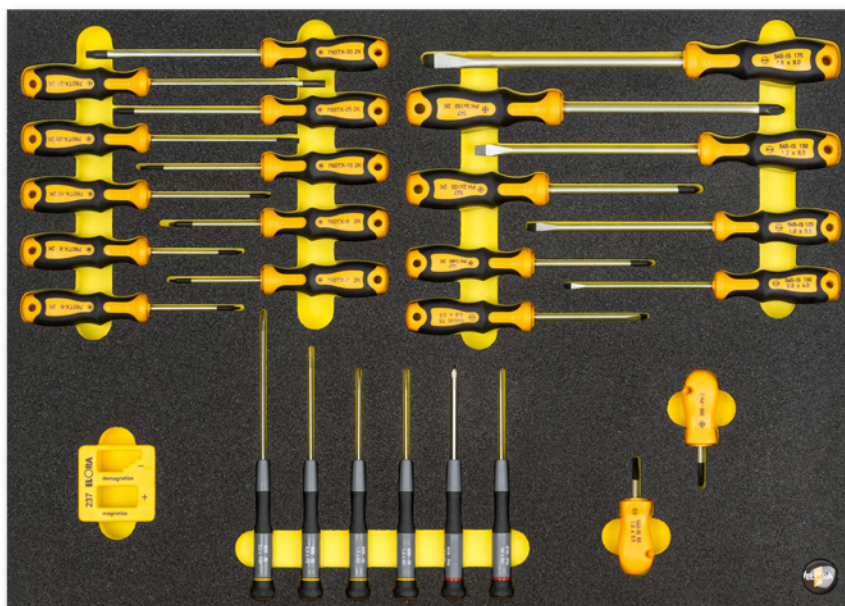

Code	Number	Contents	Pieces	Weight/g
0000414801000	OMS-48	QUATROLIT®-2C-Screwdriver for plain slotted screws ⊖ 545-IS 75, 100, 125, 150, 175 Screwdriver for plain slotted screws, short version ⊖ 543-IS 60 Screwdriver for cross slotted screws, short version ⊕ 555-PH 2 QUATROLIT®-2C-Screwdriver for cross slotted screws ⊕ 547-PH 1, 2, 3 Electronic Screwdriver for plain slotted screws ⊖ 600-IS 1,5x60, 1,8x60, 2,5x75, 3,0x100 Electronic Screwdriver for cross slotted screws ⊕ 610-PH 00, PH 0 Screwdriver for Inside TORX® screws ★ 760TX-6, 7, 8, 9, 10, 15, 20, 25, 27, 30 Magnetizer-Demagnetizer 237	1	1410
0000414807000	OMS-48L	empty module	1	160

OMS-11
MODULE-QUATROLIT®-2C-SCREWDRIVERS

- for ELORA-roller tool cabinets
- black, with yellow signal colour
- oil and grease resistant
- chemical resistant
- Width: 41,0 cm, Depth: 18,9 cm
- hard foam insert

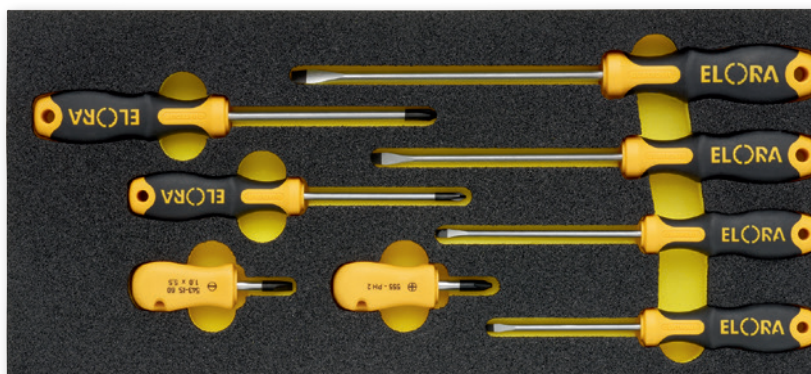

Code	Number	Contents	Pieces	Weight/g
0000411101000	OMS-11	QUATROLIT®-2C-Screwdriver for plain slotted screws 545-IS 75, 100, 125, 150 ⊖ QUATROLIT®-2C-Screwdriver for cross slotted screws 547-PH 1, 2 ⊕ Screwdriver for plain slotted screws, short version 543-IS 45 ⊖ Screwdriver for cross slotted screws, short version 555-PH 1 ⊕	1	485
0000411107000	OMS-11/38L	empty module	1	80

OMS-6

MODULE-QUATROLIT®-2C-SCREWDRIVERS

- ▶ for ELORA-roller tool cabinets
- ▶ black, with yellow signal colour
- ▶ oil and grease resistant
- ▶ chemical resistant
- ▶ Width: 41,0 cm, Depth: 18,9 cm
- ▶ hard foam insert

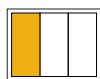

Code	Number	Contents	Pieces	Weight/g
0000410601000	OMS-6	QUATROLIT®-2C Screwdriver for plain slotted screws 539-IS 90, 100, 125, 150 649-IS 75 ⊖ QUATROLIT®-2C Screwdriver for cross slotted screws 559-PH 1, 2, 3 ⊕ Screwdriver for plain slotted screws, short version 543-IS 60 ⊖ Screwdriver for cross slotted screws, short version 555-PH 1 ⊕	1	900
0000410607000	OMS-36L/37L	empty module	1	80

OMS-7

MODULE-QUATROLIT®-2C-SCREWDRIVERS

- ▶ for ELORA-roller tool cabinets
- ▶ black, with yellow signal colour
- ▶ oil and grease resistant
- ▶ chemical resistant
- ▶ Width: 41,0 cm, Depth: 18,9 cm
- ▶ hard foam insert



Code	Number	Contents	Pieces	Weight/g
0000410701000	OMS-7	QUATROLIT®-2C-Screwdriver for plain slotted screws 539-IS 75, 90, 100, 125, 150 ⊖ QUATROLIT®-2C-Screwdriver for cross slotted screws 559-PH 1, 2, 3 ⊕ Screwdriver for plain slotted screws, short version 543-IS 60 ⊖ Screwdriver for cross slotted screws, short version 555-PH 2 ⊕	1	900
0000410607000	OMS-36L/37L	empty module	1	80

OMS-36

MODULE-QUATROLIT®-2C-SCREWDRIVERS

- ▶ for ELORA-roller tool cabinets
- ▶ black, with yellow signal colour
- ▶ oil and grease resistant
- ▶ chemical resistant
- ▶ Width: 41,0 cm, Depth: 18,9 cm
- ▶ hard foam insert

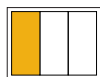

Code	Number	Contents	Pieces	Weight/g
0000413601000	OMS-36	QUATROLIT®-2C-Screwdriver for plain slotted screws 539-IS 90, 100, 125, 150 ⊖ QUATROLIT®-2C-Screwdriver for plain slotted screws 545-IS 75 QUATROLIT®-2C-Screwdriver for cross slotted screws 569-PZ 1, 2, 3 ⊕ Screwdriver for plain slotted screws, short version 543-IS 60 ⊖ Screwdriver for cross slotted screws, short version 554-PZ 2 ⊕	1	900
0000410607000	OMS-36L/37L	empty module	1	80

OMS-37
MODULE-QUATROLIT®-2C-SCREWDRIVERS

- for ELORA-roller tool cabinets
- black, with yellow signal colour
- oil and grease resistant
- chemical resistant
- Width: 41,0 cm, Depth: 18,9 cm
- hard foam insert



Code	Number	Contents	Pieces	Weight/g
0000413701000	OMS-37	QUATROLIT®-2C-Screwdriver for plain slotted screws 539-IS 75, 90, 100, 125, 150 ⇄ QUATROLIT®-2C-Screwdriver for cross slotted screws 569-PZ 1, 2, 3 ⚙ Screwdriver for plain slotted screws, short version 543-IS 60 ⇄ Screwdriver for cross slotted screws, short version 554-PZ 2 ⚙	1	900
0000410607000	OMS-36L/37L	empty module	1	80

OMS-38
MODULE-QUATROLIT®-2C-SCREWDRIVERS

- for ELORA-roller tool cabinets
- black, with yellow signal colour
- oil and grease resistant
- chemical resistant
- Width: 41,0 cm, Depth: 18,9 cm
- hard foam insert

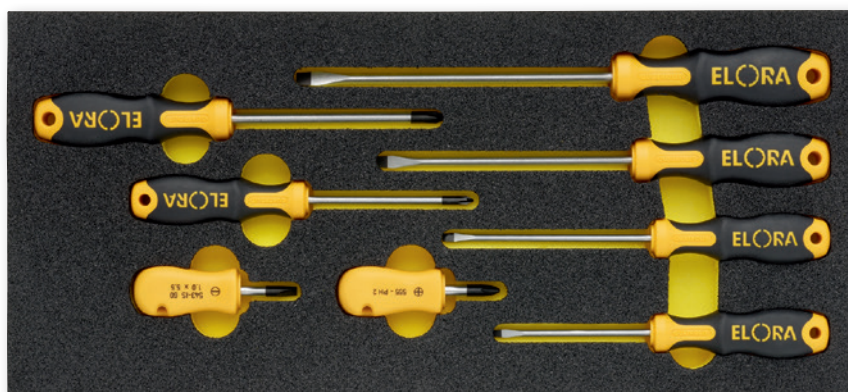

Code	Number	Contents	Pieces	Weight/g
0000413801000	OMS-38	QUATROLIT®-2C-Screwdriver for plain slotted screws 545-IS 75, 100, 125, 150 ⇄ QUATROLIT®-2C-Screwdriver for cross slotted screws 549-PZ 1, 2 ⚙ Screwdriver for plain slotted screws, short version 543-IS 45 ⇄ Screwdriver for cross slotted screws, short version 554-PZ 1 ⚙	1	470
0000411107000	OMS-11/38L	empty module	1	80

OMS-16
MODULE ENGINEER SCREWDRIVERS

- for ELORA-roller tool cabinets
- black, with yellow signal colour
- oil and grease resistant
- chemical resistant
- Width: 41,0 cm, Depth: 18,9 cm
- hard foam insert

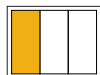
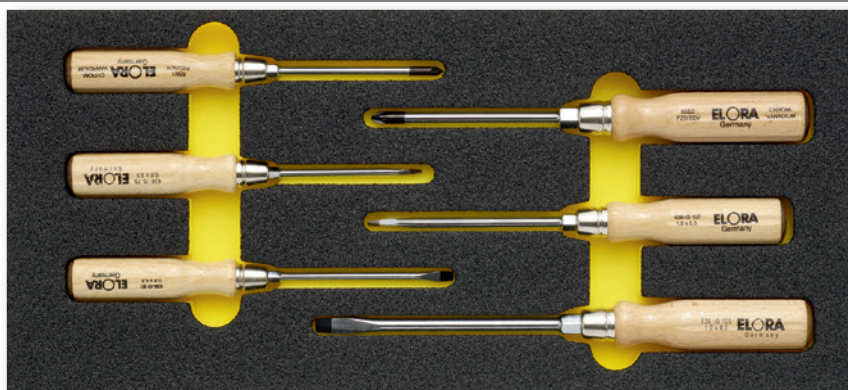

Code	Number	Contents	Pieces	Weight/g
0000411601000	OMS-16	Screwdriver for plain slotted screws with wooden handle ⇄ 636-IS 75, 90, 100, 125 Screwdriver for cross slotted screws with wooden handle ⚙ 658-PZ 1, 2	1	460
0000411607000	OMS-16L	empty module	1	80

OMS-17

MODULE ENGINEER SCREWDRIVERS

- for ELORA-roller tool cabinets
- black, with yellow signal colour
- oil and grease resistant
- chemical resistant
- Width: 41,0 cm, Depth: 18,9 cm
- hard foam insert

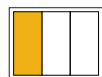
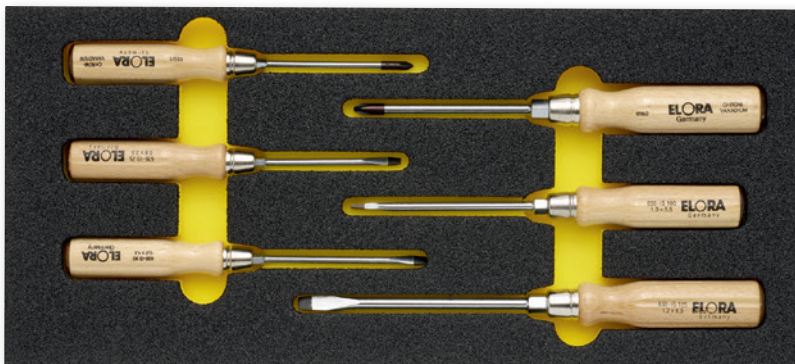

Code	Number	Contents	Pieces	Weight/g
0000411701000	OMS-17	Screwdriver for plain slotted screws with wooden handle ⚭ 636-IS 75, 90, 100, 125 Screwdriver for cross slotted screws with wooden handle ⚭ 656-PH 1, 2	1	460
0000411707000	OMS-17L	empty module	1	80

OMS-43

MODULE VDE SCREWDRIVERS

- for ELORA-roller tool cabinets
- black, with yellow signal colour
- oil and grease resistant
- chemical resistant
- Width: 41,0 cm, Depth: 18,9 cm
- hard foam insert

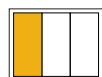
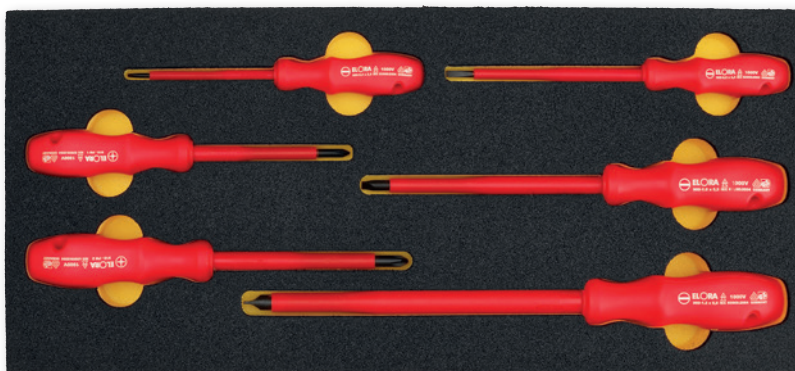

Code	Number	Contents	Pieces	Weight/g
0000414301000	OMS-43	VDE Screwdriver for plain slotted screws 900-IS 75, 106, 12510, 175 ⚭ VDE Screwdriver for cross slotted screws 910-PH 1, 2 ⚭	1	460
0000414307000	OMS-43L	empty module	1	80

OMS-10

MODULE-PLIERS

- for ELORA-roller tool cabinets
- black, with yellow signal colour
- oil and grease resistant
- chemical resistant
- Width: 41,0 cm, Depth: 18,9 cm
- hard foam insert

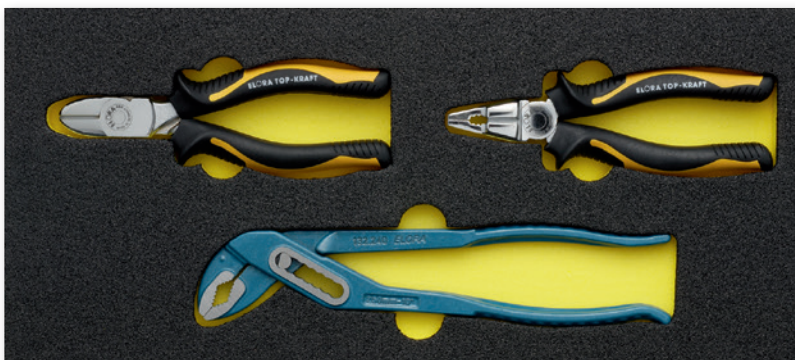

Code	Number	Contents	Pieces	Weight/g
0000411001000	OMS-10	Combination Plier, German pattern 495BI-165 Diagonal Cutter 492BI-160 Waterpump Plier 132-240	1	845
0000411007000	OMS-10L	empty module	1	80

OMS-53
MODULE-PLIERS

- for ELORA-roller tool cabinets
- black, with yellow signal colour
- oil and grease resistant
- chemical resistant
- Width: 41,0 cm, Depth: 57,3 cm
- hard foam insert

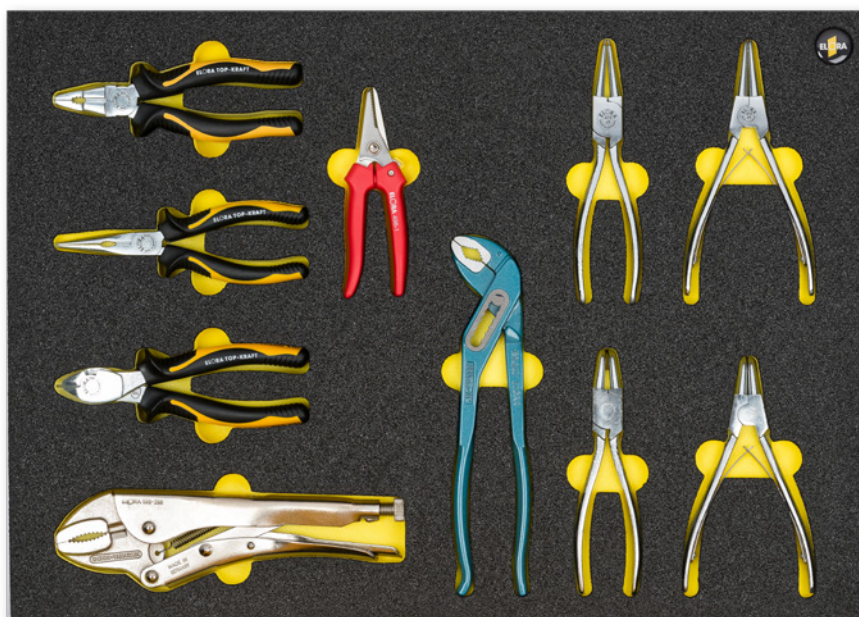

Code	Number	Contents	Pieces	Weight/g
0000415301000	OMS-53	Grip Plier with Wire Cutter, for round and flat material 500-250 Universal Scissors, straight 498-1 Heavy Duty Side Cutter 490BI-165 Snipe Nose Plier with side cutter, straight pattern Form 470BI-165 Combination Plier, German pattern 495BI-165 Waterpump Plier 132-240 Circlip Plier for internal Retaining Ring, straight jaws 473-J2 Circlip Plier for internal Retaining Ring, jaws bent at 90° 473-J21 Circlip Plier for external Retaining Ring, straight jaws 474-A2 Circlip Plier for external Retaining Ring, jaws bent at 90° 474-A21	1	2340
0000415307000	OMS-53L	empty module	1	160

OMS-5
MODULE-PLIERS

- for ELORA-roller tool cabinets
- black, with yellow signal colour
- oil and grease resistant
- chemical resistant
- Width: 41,0 cm, Depth: 18,9 cm
- hard foam insert

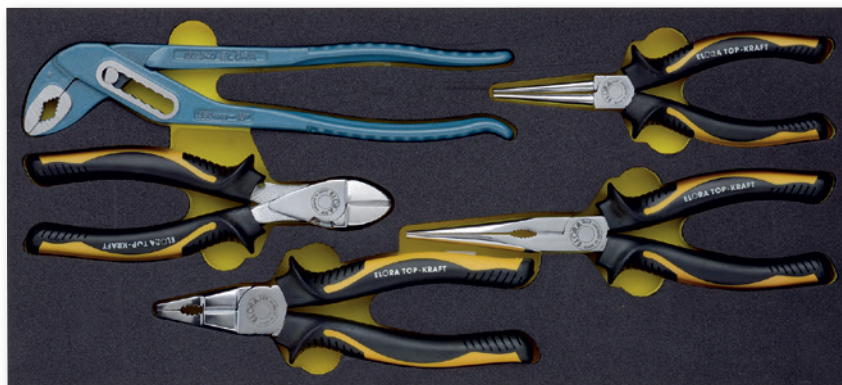

Code	Number	Contents	Pieces	Weight/g
0000410501000	OMS-5	Snipe Nose Plier with side cutter, straight pattern 470BI-200 Round Nose Plier with long jaws 477BI-170 Heavy Duty Side Cutter 490BI-165 Combination Plier, German pattern 495BI-185 Waterpump Plier 132-240	1	1200
0000410507000	OMS-5L	empty module	1	80

OMS-42

MODULE-VDE PLIERS

- ▶ for ELORA-roller tool cabinets
- ▶ black, with yellow signal colour
- ▶ oil and grease resistant
- ▶ chemical resistant
- ▶ Width: 41,0 cm, Depth: 18,9 cm
- ▶ hard foam insert

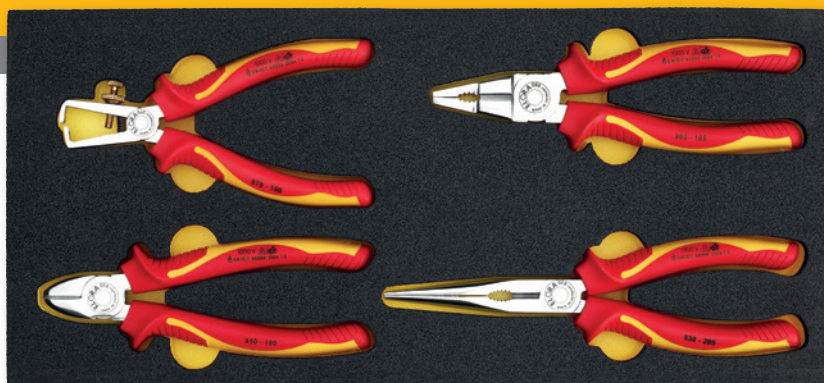

Code	Number	Contents	Pieces	Weight/g
0000414201000	OMS-42	VDE Universal Side Cutter with handle insulation 950-160 VDE Combination Plier with Handle Insulation 960-185 VDE Wire Stripper with Handle Insulation 970-160 VDE Snipe Nose Plier with Handle Insulation 930-205	1	900
0000414207000	OMS-42L	empty module	1	60

OMS-20

MODULE-CIRCLIP PLIER

- ▶ for ELORA-roller tool cabinets
- ▶ black, with yellow signal colour
- ▶ oil and grease resistant
- ▶ chemical resistant
- ▶ Width: 41,0 cm, Depth: 18,9 cm
- ▶ hard foam insert

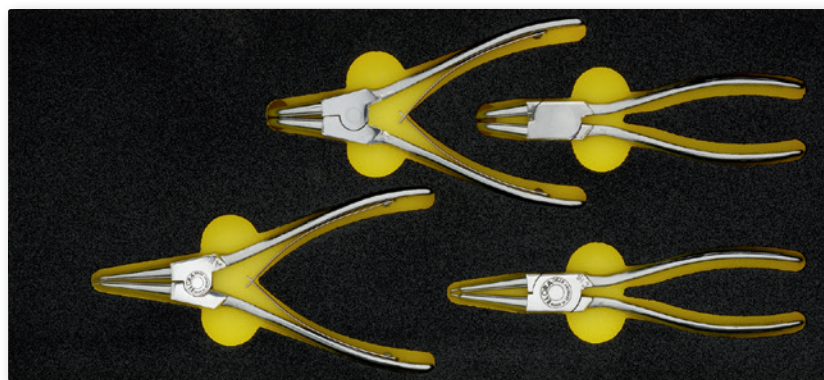

Code	Number	Contents	Pieces	Weight/g
0000412001000	OMS-20	Circlip Plier for internal Retaining Ring, straight jaws 473-J2 Circlip Plier for internal Retaining Ring, jaws bent at 90° 473-J21 Circlip Plier for external Retaining Ring, straight jaws 474-A2 Circlip Plier for external Retaining Ring, jaws bent at 90° 474-A21	1	650
0000412007000	OMS-20L	empty module	1	80

OMS-12

MODULE-HAND STRIKING TOOLS

- ▶ for ELORA-roller tool cabinets
- ▶ black, with yellow signal colour
- ▶ oil and grease resistant
- ▶ chemical resistant
- ▶ Width: 41,0 cm, Depth: 18,9 cm
- ▶ hard foam insert



Code	Number	Contents	Pieces	Weight/g
0000411201000	OMS-12	Flat Chisel, flat oval 260-200 Centre Punch 265-10 Parallel Pin Punch 271-2, 3, 4, 5, 6, 8 Engineer's Hammer, German Pattern 1665-500	1	1520
0000411207000	OMS-12L	empty module	1	80

OMS-45

MODULE-FILES AND HAND STRIKING TOOLS

- for ELORA-roller tool cabinets
- black, with yellow signal colour
- oil and grease resistant
- chemical resistant
- Width: 41,0 cm, Depth: 57,3 cm
- hard foam insert

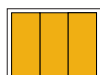

Code	Number	Contents	Pieces	Weight/g
0000414501000	OMS-45	Flat Chisel, flat oval 260-200 Cape Chisel, flat oval 261-200 Centre Punch 265-10 Parallel Pin Punch 271-3, 4, 5, 6, 8 Three Square Hollow Ground Scraper 272-150 Engineers File 208-2x200 Rectangular File 246-2x200 Half Round File 247-2x200	1	4410
0000414507000	OMS-45L	empty module	1	160

OMS-8

MODULE-HAND STRIKING TOOLS

- for ELORA-roller tool cabinets
- black, with yellow signal colour
- oil and grease resistant
- chemical resistant
- Width: 41,0 cm, Depth: 18,9 cm
- hard foam insert

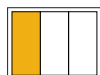

Code	Number	Contents	Pieces	Weight/g
0000410801000	OMS-8	Flat Chisel, flat oval 260-150 Flat Chisel, octagonal 262-150 Cape Chisel, flat oval 261-150	1	2200
0000410807000	OMS-8L	empty module	1	80

OMS-54

MODULE TESTING AND MEASURING TOOLS

- for ELORA-roller tool cabinets
- black, with yellow signal colour
- oil and grease resistant
- chemical resistant
- Width: 41,0 cm, Depth: 18,9 cm
- hard foam insert

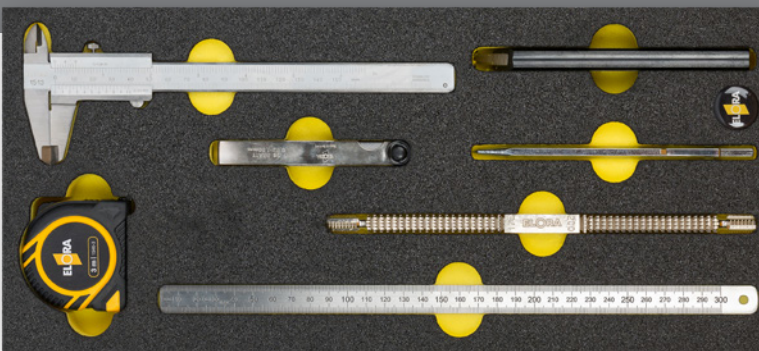
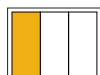





Code	Number	Contents	Pieces	Weight/g
0000415401000	OMS-54	Precision Vernier Caliper 1513 Thread Restoring File 258 MM Carbide Hexagon Engineer's Scriber 1592 Feeler Gauge 188-26M	1	755
0000415407000	OMS-54L	empty module	1	80

WS OMS-6

AUTOMOTIVE

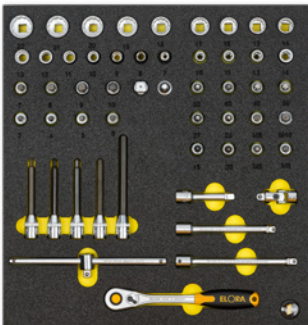
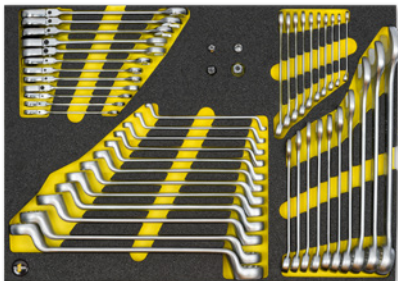
➤ suitable for Roller Tool Cabinet Buddy ELORA-No. 1210-L7, Super Caddy ELORA-No. 1220-L7 and L8, ToolJET ELORA-No. 1225-L7

01

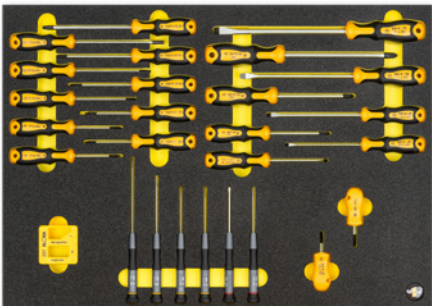
Code	Number	Contents	Pieces	Weight/g
0000501220006	WS OMS-6	177 Tools	1 assortment	25990
OMS-49		<p>Bi-Hexagon Sockets ○ 870- 7, 8, 9, 10, 11, 12, 13, 14, 15, 16, 17, 18, 19, 20, 21, 22 mm Screwdriver Sockets ● 3510-IN 3, 4, 5, 6, 7, 8, 9, 10 Screwdriver Sockets long for inside hexagon screws ● 3510-INL 4x100, 5x100, 6x100, 8x100, 10x130 Screwdriver Sockets for inside-TORX® screws ★ 3244-TX 15, 20, 25, 27, 30, 40, 45, 50 Screwdriver Sockets for inside multi-point B & S and XZN screws ● 3530-XZN 5, 6, 8, 10 Screwdriver Sockets for Outside-TORX® screws ⊕ 870-TXE 10, 11, 12, 14 Reversible Ratchet 870-1D Sliding T-Bar 870-8 Universal Joint 870-9 Extension Bar, swivelling 50 mm 870-3V Extension Bar, swivelling 125 mm 870-35V Extension Bar, swivelling 150 mm 870-4V Socket Converter 870-10, 1/4" ■ 3/8" ○ Socket Converter 770-L14, 1/2" ■ 3/8" ○</p>		
53-pcs.				
OMS-51		<p>Combination Spanners, bent 203- 6, 7, 8, 9, 10, 11, 12, 13, 14, 15, 16, 17, 18, 19, 21, 22, 24, 27, 30, 32, mm Double-Ended Ring Spanners, DIN 838 110- 6x7, 8x9, 10x11, 12x13, 14x15, 16x17, 18x19, 20x22, 21x23, 24x27, 25x28, 30x32 mm Combination Spanner with Joint-Ring Ratchet 204R- 8, 9, 10, 11, 12, 13, 14, 15, 16, 17, 18, 19 mm Adapter Drives for bits 1/4", 3/8", 1/2" und 1/4" Bit-Adaptor 118- 1, 2, 3, 4</p>		
48-pcs.				
OMS-53		<p>Grip Plier with Wire Cutter, for round and flat material 500-250 Universal Scissors, straight 498-1 Heavy Duty Side Cutter 490BI-165 Snipe Nose Plier with side cutter, straight pattern Form 470BI-165 Combination Plier, German pattern 495BI-165 Waterpump Plier 132-240 Circlip Plier for internal Retaining Ring, straight jaws 473-J2 Circlip Plier for internal Retaining Ring, jaws bent at 90° 473-J21 Circlip Plier for external Retaining Ring, straight jaws 474-A2 Circlip Plier for external Retaining Ring, jaws bent at 90° 474-A21</p>		
10-pcs.				
OMS-47		<p>Combination Spanner with Ring Ratchet, reversible 204-J 8, 10, 12, 13, 17, 19 mm ○ Double-Ended Ring Spanner for outside TORX®-Screws 119TXE- 6x8, 10x12, 14x18, 20x24 mm ⊕ Open Ring Spanner 121-10x11 mm ○ Adjustable Wrench 60-12 MB Spark Plug Socket 1/2" ○  771-LTZ 16, 18, 20, 8 mm Socket Converter 770-L14, 1/2" ■ 3/8" ○ Impact Socket 1/2" ○ 790LTP-17, 19, 21 mm Torque Wrench with Vernier Scale 2179-60 10-60 Nm, 2179-200 40-200 Nm Engineer's Hammer, German Pattern 1665-500 Feeler Gauge 188-13 M Tyre Lever 165-300, 165-500 Brush for Brake Service 293 BS Seal Flat Scraper 290-1</p>		
39-pcs.				
OMS-48		<p>QUATROLIT®-2C-Screwdriver for plain slotted screws ⊖ 545-IS 75, 100, 125, 150, 175 Screwdriver for plain slotted screws, short version ⊖ 543-IS 60 Screwdriver for cross slotted screws, short version ⊕ 555-PH 2 QUATROLIT®-2C-Screwdriver for cross slotted screws ⊕ 547-PH 1, 2, 3 Electronic Screwdriver for plain slotted screws ⊖ 600-IS 1,5x60, 1,8x60, 2,5x75, 3,0x100 Electronic Screwdriver for cross slotted screws ⊕ 610-PH 00, PH 0 Screwdriver for Inside TORX® screws ★ 760TX-6, 7, 8, 9, 10, 15, 20, 25, 27, 30 Magnetizer-Demagnetizer 237</p>		
27-pcs.				

MS-2

MODULE-COMBINATION SPANNERS, CRANKED

- black, with transparent cover
- Width: 31,5 cm, Depth: 14,5 cm
- stable ABS plastic



Code	Number	Contents	Pieces	Weight/g
0000502001000	MS-2	Combination Spanners, cranked 205- 8, 10, 11, 13, 14, 17, 19, 22 mm	1	976
0000502007000	MS-2L	empty module	1	140

MS-6

MODULE--COMBINATION SPANNERS, BENT

- black, with transparent cover
- Width: 31,5 cm, Depth: 14,5 cm
- stable ABS plastic



Code	Number	Contents	Pieces	Weight/g
0000506001000	MS-6	Combination Spanners, bent 203-8, 10, 11, 13, 17, 19, 22, 24 mm	1	1028
0000502007000	MS-2L	empty module	1	140

MS-10

MODULE-COMBINATION SPANNER WITH RING RATCHET

- black, with transparent cover
- Width: 31,5 cm, Depth: 14,5 cm
- stable ABS plastic



Code	Number	Contents	Pieces	Weight/g
0000510001000	MS-10	Combination Spanners with Ring Ratchets 204- 8, 9, 10, 12, 13, 14, 17, 19 mm	1	940
0000502007000	MS-2L	empty module	1	140

MS-50
MODULE-SOCKET SET 1/4"

- black, with transparent cover
- Width: 31,5 cm, Depth: 14,5 cm
- stable ABS plastic



6,3

1/4"



Code	Number	Contents	Pieces	Weight/g
0000550001000	MS-50	Screwdriver Sockets for inside hexagon screws ★ 3243-TX 8, 9, 10, 15, 20, 25, 27, 30, 40 Sockets for outside TORX® screws ☼ 1455-TXE 4, 5, 6, 7, 8, 10, 11 Screwdriver Sockets for inside hexagon screws ● 1455-IN 3, 4, 5, 6, 8 mm Hexagon Sockets ○ 4, 4,5, 5, 5,5, 6, 7, 8, 9, 10, 11, 12, 13, 14 mm Reversible Ratchet 1450-1D Spinner Handle 1450-3 Sliding T-Bar 1450-4 Universal Joint 1450-8 Extension Bar 50 mm 1450-11 Extension Bar 100 mm 1450-5 Extension Bar 150 mm 1450-12	1	892
0000550007000	MS-50L	empty module	1	95

MS-11/12
MODULE-SOCKET SET 1/2"

- black, with transparent cover
- Width: 31,5 cm, Depth: 14,5 cm
- stable ABS plastic



12,5

1/2"



Code	Number	Contents	Pieces	Weight/g
0000511001000	MS-11	Bihexagon Sockets ○ 770-LM 10, 11, 12, 13, 14, 15, 16, 17, 18, 19, 20, 22 mm Reversible Ratchet 770-L1D Extension Bar 250 mm 770-L6 Sliding T-Bar 770-L3	1	2140
0000512001000	MS-12	same as MS-11, but all sockets in hexagon pattern ○	1	2140
0000511007000	MS-11L	empty module	1	95

MS-14

MODULE-TORX®-TOOLS

- black, with transparent cover
- Width: 31,5 cm, Depth: 14,5 cm
- stable ABS plastic



12,5

1/2"



Code	Number	Contents	Pieces	Weight/g
0000514001000	MS-14	Screwdriver Sockets for inside TORX® screws ☸ 3245 TX 20, 25, 27, 30, 40, 45, 50, 55, 60 TORX®-Ball End Key Set ☸ 162S-TXKU 9, 10, 15, 20, 25, 27, 30, 40	1	918
0000513007000	MS-13L	empty module	1	95

MS-13

MODULE-ALLEN KEYS SOCKET SET 1/2"

- black, with transparent cover
- Width: 31,5 cm, Depth: 14,5 cm
- stable ABS plastic



12,5

1/2"



Code	Number	Contents	Pieces	Weight/g
0000513001000	MS-13	Screwdriver Socket 1/2" for Inside hexagon screws ● 3210 IN 4, 5, 6, 8, 10, 12, 14, 17, 19 mm Ball End Hexagon Key Set, extra long, 1,5-10 mm 159SKU	1	1486
0000513007000	MS-13L	empty module	1	95

MS-38

MODULE-QUATROLIT® 2C-SCREWDRIVER

- black, with transparent cover
- Width: 31,5 cm, Depth: 14,5 cm
- stable ABS plastic



Code	Number	Contents	Pieces	Weight/g
0000538001000	MS-38	QUATROLIT®-2C-Screwdrivers for plain slotted screws ☰ 545-IS 75, 100, 125, 150 QUATROLIT®-2C-Screwdrivers for cross slotted screws ☩ 547-PH 1, 2	1	455
0000531007000	MS-31L/41L	empty module	1	96

MS-39
MODULE-QUATROLIT® 2C-SCREWDRIVER

- black, with transparent cover
- Width: 31,5 cm, Depth: 14,5 cm
- stable ABS plastic



Code	Number	Contents	Pieces	Weight/g
0000539001000	MS-39	QUATROLIT®-2C-Screwdrivers for plain slotted screws ⊖ 545-IS 75, 100, 125, 150 QUATROLIT®-2C-Screwdrivers for cross slotted screws ⊕ 549-PZ 1, 2	1	456
0000531007000	MS-31L/41L	empty module	1	96

MS-36
MODULE-QUATROLIT® 2C-SCREWDRIVER

- black, with transparent cover
- Width: 31,5 cm, Depth: 14,5 cm
- stable ABS plastic



Code	Number	Contents	Pieces	Weight/g
0000536001000	MS-36	QUATROLIT®-2C-Screwdrivers for plain slotted screws ⊖ 539-IS 75, 100, 125, 150 QUATROLIT®-2C-Screwdrivers for cross slotted screws ⊕ 559-PH 1, 2	1	574
0000531007000	MS-31L/41L	empty module	1	96

MS-37
MODULE-QUATROLIT® 2C-SCREWDRIVER

- black, with transparent cover
- Width: 31,5 cm, Depth: 14,5 cm
- stable ABS plastic



Code	Number	Contents	Pieces	Weight/g
0000537001000	MS-37	QUATROLIT®-2C-Screwdrivers for plain slotted screws ⊖ 539-IS 75, 100, 125, 150 QUATROLIT®-2C-Screwdrivers for cross slotted screws ⊕ 569-PZ 1, 2	1	575
0000531007000	MS-31L/41L	empty module	1	96

MS-40

MODULE-ENGINEER SCREWDRIVER

- black, with transparent cover
- Width: 31,5 cm, Depth: 14,5 cm
- stable ABS plastic



Code	Number	Contents	Pieces	Weight/g
0000540001000	MS-40	Screwdriver for plain slotted screws with wooden handle 636-IS 75, 90, 100, 125 Screwdriver for cross slotted screws with wooden handle 656-PH 1, 2	1	500
0000531007000	MS-31L/41L	empty module	1	96

MS-41

MODULE-ENGINEER SCREWDRIVER

- black, with transparent cover
- Width: 31,5 cm, Depth: 14,5 cm
- stable ABS plastic



Code	Number	Contents	Pieces	Weight/g
0000541001000	MS-41	Screwdriver for plain slotted screws with wooden handle 636-IS 75, 90, 100, 125 Screwdriver for cross slotted screws with wooden handle 658-PZ 1, 2	1	500
0000531007000	MS-31L/41L	empty module	1	96

MS-32

MODUL-VDE-SCREWDRIVER

- black, with transparent cover
- Width: 31,5 cm, Depth: 14,5 cm
- stable ABS plastic

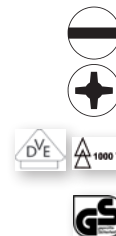

Code	Number	Contents	Pieces	Weight/g
0000532001000	MS-32	VDE-Screwdriver for plain slotted screws 900IS-75, 106, 12510, 175 VDE-Screwdriver for cross slotted screws 910-PH 1, 2	1	518
0000531007000	MS-31L/41L	empty module	1	96

MS-23
MODUL-VDE-PLIERS

- black, with transparent cover
- Width: 31,5 cm, Depth: 14,5 cm
- stable ABS plastic



Code	Number	Contents	Pieces	Weight/g
0000523001000	MS-23	VDE Combination Plier with Handle Insulation 960-185 VDE Snipe Nose Plier with Handle Insulation 930-205 VDE Universal Side Cutter with handle insulation 950-160	1	802
0000521007000	MS-21L	empty module	1	96

MS-21
MODULE-PLIERS

- black, with transparent cover
- Width: 31,5 cm, Depth: 14,5 cm
- stable ABS plastic



Code	Number	Contents	Pieces	Weight/g
0000521001000	MS-21	Combination Plier, German pattern 495BI-185 Snipe Nose Plier with Side Cutter, straight pattern 470BI-200 Heavy Duty Side Cutter 490BI-165	1	806
0000521007000	MS-21L	empty module	1	96

MS-25

MODUL-CIRCLIP PLIER SET

- black, with transparent cover
- Width: 31,5 cm, Depth: 14,5 cm
- stable ABS plastic

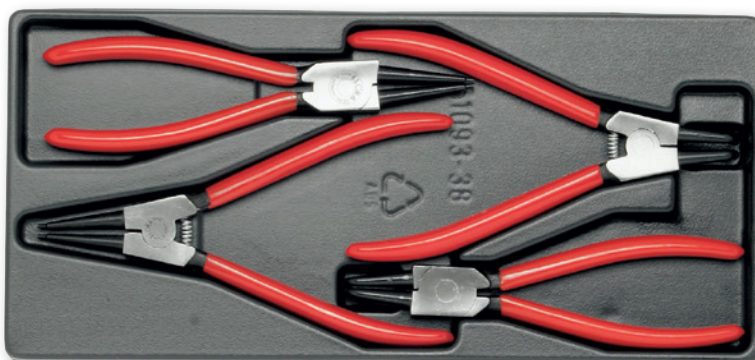

Code	Number	Contents	Pieces	Weight/g
0000525001000	MS-25	Circlip Plier for internal Retaining Ring, straight jaws 383-J2 Circlip Plier for internal Retaining Ring, jaws bent at 90° 383-J21 Circlip Plier for external Retaining Ring, straight jaws 384-A2 Circlip Plier for external Retaining Ring, jaws bent at 90° 384-A21	1	783
0000524007000	MS-25L	empty module	1	96

MS-26

MODUL-CIRCLIP PLIER SET

- black, with transparent cover
- Width: 31,5 cm, Depth: 14,5 cm
- stable ABS plastic

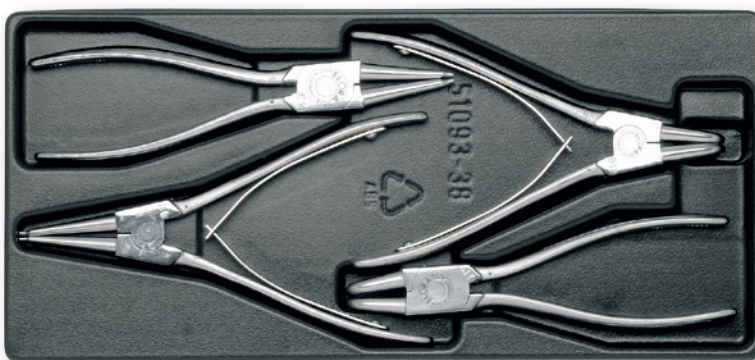

Code	Number	Contents	Pieces	Weight/g
0000526001000	MS-26	Circlip Plier for internal Retaining Ring, straight jaws 473-J2 Circlip Plier for internal Retaining Ring, jaws bent at 90° 473-J21 Circlip Plier for external Retaining Ring, straight jaws 474-A2 Circlip Plier for external Retaining Ring, jaws bent at 90° 474-A21	1	769
0000524007000	MS-25L	empty module	1	96



ELORA

Zielerreicherung / Achievement
 Zeichen der Wertschöpfung / Signs of value added
 Familienunternehmen in dritter Generation
 Umzug in die ELORA-Werkstatt / Moved to the advanced building
 Unternehmenskultur / Management in the second generation
 Erweiterung der Produktion / Expansion of the production plant
 Neubau des Zentrals in München / New construction of the branch factory
 ELORA als Anbieter für In- und Ausland / Not an active domestic and foreign supplier
 in einem LKW nach drei Abgängen / in first batch after the years of war
 ELORA-Lieferanten / ELORA.com
 der Zulieferer / in first year
 der Welt / in first year
 der Welt / in first year
 der Welt / in first year

NFT

SCHLAGWERKZEUGE
 STRIKING TOOLS
ELORA

ZANGEN, BOLZENKLEIDER UND RILSCHSCHEREN
 PLIERS, BOLT CUTTERS AND SHEARS
ELORA

STECKSCHLÜSSEL UND IMPACT WERKZEUGE
 SOCKET ASSORTMENTS AND IMPACT TOOLS
ELORA

STECKSCHLÜSSEL UND IMPACT WERKZEUGE
 SOCKET ASSORTMENTS AND IMPACT TOOLS

WS-1M















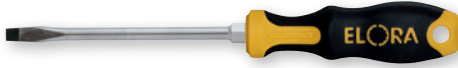

TOOL ASSORTMENT

- suitable for Tool Cabinet ELORA-No. 1100L
- suitable for Roller Tool Cabinet Buddy ELORA-No. 1210-L7, Super Caddy ELORA-No. 1220-L7 and L8, ToolJET ELORA-No. 1225-L7

Code	Number	Contents	Pieces	Weight/g
0000500101000	WS-1M	64 metric tools	1 assortment	8300
205-...	8, 9, 10, 11, 12, 13, 14, 15, 16, 17, 19, 22 mm			
1 pc. each				
770-LM...	10, 11, 12, 13, 14, 15, 16, 17, 19, 22, 24, 27, 30, 32 mm			
1 pc. each				
158R-1	2; 2,5; 3; 4; 5; 6; 8; 10 mm			
1 pc. each				
770-L1D	270 mm			
1 pc. each				
770-L3	300 mm			
1 pc. each				
770-L5/L6	125 mm 250 mm			
1 pc. each				
770-L7	75 mm			
1 pc. each				
539-IS...	100, 125, 150			
1 pc. each				
545-IS75				
1 pc. each				
547-PH...	PH1 PH2 PH3			
1 pc. each				
1665-300				
1 pc. each				
266-K	262-125 mm 262-150 mm 263-125 mm 264-120x10x4 mm 264-120x12x4 mm 265-120x10mm			
1 pc. each				
271-K	271-150x2 mm 271-150x3 mm 271-150x4 mm 271-150x5 mm 271-150x6 mm 271-150x8 mm			
1 pc. each				
132-240				
1 pc. each				
495-BI 165				
1 pc. each				
246-2x200				
1 pc. each				
247-2x200				
1 pc. each				
248-2x200				
1 pc. each				

WS-1A
TOOL ASSORTMENT

- suitable for Tool Cabinet ELORA-No. 1100L
- suitable for Roller Tool Cabinet Buddy ELORA-No. 1210-L7, Super Caddy ELORA-No. 1220-L7 and L8, ToolJET ELORA-No. 1225-L7

Code	Number	Contents	Pieces	Weight/g
0000600101000	WS-1A	64 inch tools	1 assortment	8300
205-...	5/16, 3/8, 7/16, 1/2, 9/16, 5/8, 11/16, 3/4, 13/16, 7/8, 15/16, 1 AF			
1 pc. each				
770-LM...	3/8, 7/16, 1/2, 9/16, 19/32, 5/8, 11/16, 3/4, 13/16, 7/8, 1, 1.1/16, 1.1/8, 1.1/4 AF			12,5 1/2"
1 pc. each				
158R-3	1/16, 5/64, 3/32, 1/8, 5/32, 3/16, 7/32, 1/4 AF			
1 pc. each				
770-L1D	270 mm			12,5 1/2"
1 pc. each				
770-L3	300 mm			12,5 1/2"
1 pc. each				
770-L5/L6	125 mm 250 mm			12,5 1/2"
1 pc. each				
770-L7	75 mm			12,5 1/2"
1 pc. each				
539-IS...	100, 125, 150			
1 pc. each				
545-IS75				
1 pc. each				
547-PH...	PH1 PH2 PH3			
1 pc. each				
1665-300				
1 pc. each				
266-K	262-125 mm 262-150 mm 263-125 mm 264-120x10x4 mm 264-120x12x4 mm 265-120x10mm			
1 pc. each				
271-K	271-150x2 mm 271-150x3 mm 271-150x4 mm 271-150x5 mm 271-150x6 mm 271-150x8 mm			
1 pc. each				
132-240				
1 pc. each				
495-BI165				
1 pc. each				
246-2x200				
1 pc. each				
247-2x200				
1 pc. each				
248-2x200				
1 pc. each				

WS-2M

TOOL ASSORTMENT

- suitable for tool cabinet ELORA-No. 1100L
- suitable for Roller Tool Cabinet Buddy ELORA-No. 1210-L7, Super Caddy ELORA-No. 1220-L7 and L8, ToolJET ELORA-No. 1225-L7
- suitable for cantilever tool box ELORA-Nr. 810-L

Code	Number	Contents	Pieces	Weight/g
0000500201000	WS-2M	90 metric tools	1 assortment	15000
100-...	6x7, 8x9, 10x11, 12x13, 14x15, 16x17, 18x19, 20x22, 24x27, 30x32 mm			
1 pc. each				
110-...	6x7, 8x9, 10x11, 12x13, 14x15, 16x17, 18x19, 20x22, 24x27, 30x32 mm			
1 pc. each				
770-LM...	10, 11, 12, 13, 14, 15, 16, 17, 18, 19, 21, 22, 24, 27, 30, 32 mm			12,5 1/2"
1 pc. each				
157-S11M	4, 4,5, 5, 5,5, 6, 6,5, 7, 7,5 mm			
1 pc. each				
158-R1	2; 2,5; 3; 4; 5; 6; 8; 10 mm			
1 pc. each				
188-13M	0,05, 0,10, 0,15, 0,20, 0,25, 0,30, 0,40, 0,50, 0,60, 0,70, 0,80, 0,90, 1,00			
770-L1D	270 mm			12,5 1/2"
770-L3	300 mm			12,5 1/2"
770-L5/L6	125 mm 250 mm			12,5 1/2"
1 pc. each				
770-L7	75 mm			12,5 1/2"
222-16x20,8				
545-IS...	75, 100, 125, 150, 200			
547-PH...	PH1 PH2 PH3			
1 pcs. each				
246-2x200				
247-2x200				
248-2x200				
132-240				
500-250				
1665-500				
470-BI 200				
490-BI 165				
495-BI 185				
1660-32				
251-45				
60-8A				
242KM-250	250 ml			
165-500	2 pcs.			
189				
1542-3				
249 S6				
250-4				
266-K	262-125 mm 262-150 mm 263-125 mm 264-120x10x4 mm 264-120x12x4 mm 265-120x10mm			1 pc. each

WS-2A
TOOL ASSORTMENT

- suitable for tool cabinet ELORA-No. 1100L
- suitable for Roller Tool Cabinet Buddy ELORA-No. 1210-L7, Super Caddy ELORA-No. 1220-L7 and L8, ToolJET ELORA-No. 1225-L7
- suitable for cantilever tool box ELORA-Nr. 810-L

Code	Number	Contents	Pieces	Weight/g
0000600201000	WS-2A	89 inch tools	1 assortment	14500
100A-...	1/4x5/16, 5/16x3/8, 3/8 x7/16, 7/16x1/2, 1/2x9/16, 9/16x5/8, 5/8x11/16, 11/16x3/4, 3/4x7/8, 13/16x7/8, 15/16x1, 1.1/16x1.1/4 AF			
1 pc. each				
110A-...	1/4x5/16, 3/8x7/16, 1/2x9/16, 5/8x11/16, 3/4x25/32, 13/16x7/8, 15/16x1, 1.1/16x1.1/4 AF			
1 pc. each				
770-LA...	3/8, 7/16, 1/2, 9/16, 19/32, 5/8, 11/16, 3/4, 13/16, 25/32, 7/8, 15/16, 1, 1.1/8, 1.1/4 AF		12,5	1/2"
1 pc. each				
157-S11AF	3/16, 7/32, 1/4, 9/32, 5/16, 11/32, 3/8 AF			
1 pc. each				
158-R3	1/16, 5/64, 3/32, 1/8, 5/32, 3/16, 7/32, 1/4 AF			
1 pc. each				
188-13Z	.002, .003, .004, .005, .006, .008, .010, .012, .015, .020, .025, .030, 035			
770-L1D	270 mm		12,5	1/2"
770-L3	300 mm		12,5	1/2"
770-L5/L6	125 mm 250 mm		12,5	1/2"
1 pc. each				
770-L7	75 mm		12,5	1/2"
222-16x20,8				
545-IS...	75, 100, 125, 150, 200			
547-PH...	PH1 PH2 PH3			
1 pc. each				
246-2x200				
247-2x200				
248-2x200				
132-240				
500-250				
1665-500				
470-BI200				
490-BI 165				
495-BI 185				
1660-32				
251-45				
60-8A				
242KM-250	250 ml			
165-500	2 pcs.			
189				
1542-3				
249 S6				
250-4				
266-K	262-125 mm 262-150 mm 263-125 mm 264-120x10x4 mm 264-120x12x4 mm 265-120x10mm			
1 pc. each				

WS-3M

TOOL ASSORTMENT

- suitable for tool cabinet ELORA-No. 1100L
- suitable for Roller Tool Cabinet Buddy ELORA-No. 1210-L7, Super Caddy ELORA-No. 1220-L7 and L8, ToolJET ELORA-No. 1225-L7
- suitable for cantilever tool box ELORA-Nr. 810-L

Code	Number	Contents	Pieces	Weight/g
0000500301000	WS-3M	80 metric tools	1 assortment	17500
100-...	6x7, 8x9, 10x11, 12x13, 14x15, 16x17, 18x19, 20x22, 21x23, 24x27, 25x28, 30x32 mm			
1 pc. each				
110-...	6x7, 8x9, 10x11, 12x13, 14x15, 16x17, 18x19, 20x22, 21x23, 24x27, 25x28, 30x32 mm			
1 pc. each				
205-...	8, 9, 10, 11, 13, 17, 19, 22 mm			
1 pc. each				
770-LM...	10, 11, 12, 13, 14, 15, 16, 17, 18, 19, 20, 21, 22, 23, 24, 25, 26, 27, 30, 32 mm			12,5 1/2"
1 pc. each				
770-L1D	270 mm			12,5 1/2"
770-L3	300 mm			12,5 1/2"
770-L5/L6	125 mm 250 mm			12,5 1/2"
1 pc. each				
770-L7	75 mm			12,5 1/2"
222-16x20,8				
165-500	2 pcs.			
60-8A				
60-10A				
132-240				
470-BI 200				
490-BI 165				
495-BI 185				
473-J2				IN
473-J21				IN
539-IS...	100, 125, 150, 200		1 pc. each	
545-IS...	75, 150		1 pc. each	
547-PH...	PH1 PH2		1 pc. each	
260-150				
261-150				
265-10				
264-...	264-120x10x2 mm 264-120x10x3 mm 264-120x12x4 mm 264-120x12x5 mm 264-120x12x6 mm		1 pc. each	
1665-500				
246-2x200				
247-2x200				
248-2x200				
189				

WS-3A
TOOL ASSORTMENT

- suitable for tool cabinet ELORA-No. 1100L
- suitable for Roller Tool Cabinet Buddy ELORA-No. 1210-L7, Super Caddy ELORA-No. 1220-L7 and L8, ToolJET ELORA-No. 1225-L7
- suitable for cantilever tool box ELORA-Nr. 810-L

Code	Number	Contents	Pieces	Weight/g
0000600301000	WS-3A	79 inch tools	1 assortment	17300
100A-...	1/4x5/16, 5/16x3/8, 3/8 x7/16, 7/16x1/2, 1/2x9/16, 9/16x5/8, 5/8x11/16, 11/16x3/4, 3/4x7/8, 13/16x7/8, 15/16x1, 1.1/16x1.1/4 AF			
1 pc. each				
110A-...	1/4x5/16, 5/16x3/8, 3/8x7/16, 7/16x1/2, 1/2x9/16, 9/16x5/8, 5/8x11/16, 3/4x25/32, 13/16x7/8, 15/16x1, 1x1.1/8, 1.1/16x1.1/4 AF			
1 pc. each				
205A-...	5/16, 3/8, 7/16, 1/2, 9/16, 5/8, 11/16, 3/4 AF			
1 pc. each				
770-LA...	3/8, 7/16, 1/2, 9/16, 19/32, 5/8, 11/16, 3/4, 25/32, 13/16, 7/8, 15/16, 31/32, 1, 1.1/16, 1.1/8, 1.3/16, 1.1/4 AF			 12,5 1/2"
1 pc. each				
770-L1D	270 mm			12,5 1/2"
770-L3	300 mm			12,5 1/2"
770-L5/L6	125 mm 250 mm			12,5 1/2"
1 pc. each				
770-L7	75 mm			12,5 1/2"
222-16x20,8				
165-500	2 pcs.			
60-8A				
60-10A				
132-240				
470-BI 200				
490-BI 165				
495-BI 185				
473-J2				
473-J21				
539-IS...	100, 125, 150, 200		1 pc. each	
545-IS...	75, 150		1 pc. each	
547-PH...	PH1 PH2		1 pc. each	
260-150				
261-150				
265-10				
264-...	264-120x10x2 mm 264-120x10x3 mm 264-120x12x4 mm 264-120x12x5 mm 264-120x12x6 mm		1 pc. each	
1665-500				
246-2x200				
247-2x200				
248-2x200				
189				

WS-4M

TOOL ASSORTMENT "MECHATRONIC"

- suitable for tool cabinet ELORA-No. 1100L
- suitable for Roller Tool Cabinet Buddy ELORA-No. 1210-L7, Super Caddy ELORA-No. 1220-L7 and L8, ToolJET ELORA-No. 1225-L7
- suitable for cantilever tool box ELORA-Nr. 810-L
- suitable for hard protective case ELORA-No. 1380-L and hard protective trolley case ELORA-No. 1381-L

Code	Number	Contents	Pieces	Weight/g
0000500401101	WS-4M	131 metric tools	1 assortment	22800
205-...	6, 7, 8, 9, 10, 11, 12, 13, 14, 15, 16, 17, 18, 19, 20, 21, 22 mm			
1 pc. each				
1455-M...	4, 4.5, 5, 5.5, 6, 7, 8, 9, 10, 11, 13 mm			
1 pc. each		6,3 1/4"		
770-LM...	10, 11, 12, 13, 14, 15, 16, 17, 19, 22, 24, 27, 30, 32 mm			
1 pc. each		12,5 1/2"		
159-...	1.5, 2, 2.5, 3, 4, 5, 6, 8, 10, 12 mm			
1 pc. each				
1450-1D	145 mm		6,3 1/4"	
1450-4	270 mm		6,3 1/4"	
1450-5	100 mm		6,3 1/4"	
1450-8	45 mm		6,3 1/4"	
1450-3	150 mm		6,3 1/4"	
1450-16	25 mm		6,3 1/4"	
770-L1D	270 mm		12,5 1/2"	
770-L3	300 mm		12,5 1/2"	
770-L5/L6	125 mm 250 mm		12,5 1/2"	
1 pc. each				
770-L7	75 mm		12,5 1/2"	
1080				
1513				
1591				
1543-3				
242KM-125	125 ml			
466A-16,0				
930-205				
960-185				
950-160				
900IS-...	108, 12508			
1 pc. each				
910PH-...	PH1 PH2			
1 pc. each				
564N				
561				
600-IS...	1,2 x 60, 1,5 x 60 2,0 x 60			
610-PH...	00 x 60 0 x 60			
4680-MH E				
4550-F E				
262-150				
265-10				
271-...	3,0, 5,0			
1 pc. each				
246-2x200				
207-2x200				
248-2x200				
189				
1665-500				
1690-30				
3436-S36	Bit-Box 36 pcs.			

WS-4A
TOOL ASSORTMENT "MECHATRONIC"

- suitable for tool cabinet ELORA-No. 1100L
- suitable for Roller Tool Cabinet Buddy ELORA-No. 1210-L7, Super Caddy ELORA-No. 1220-L7 and L8, ToolJET ELORA-No. 1225-L7
- suitable for cantilever tool box ELORA-Nr. 810-L
- suitable for hard protective case ELORA-No. 1380-L and hard protective trolley case ELORA-No. 1381-L

Code	Number	Contents	Pieces	Weight/g
0000600401101	WS-4A	128 inch tools	1 assortment	22800
205A-...	1/4, 5/16, 3/8, 7/16, 1/2, 9/16, 19/32, 5/8, 11/16, 3/4, 13/16, 7/8, 15/16, 1, 1.1/16, 1.1/4 AF			
1 pc. each				
1455-A...	3/16, 7/32, 1/4, 9/32, 5/16, 11/32, 3/8, 7/16, 1/2 AF			
1 pc. each		6,3 1/4"		
770-LM...	3/8, 7/16, 1/2, 9/16, 19/32, 5/8, 11/16, 3/4, 13/16, 7/8, 1, 1.1/16, 1.1/8, 1.1/4 AF			
1 pc. each		12,5 1/2"		
159A-...	1/16, 5/64, 3/32, 1/8, 5/32, 3/16, 7/32, 1/4, 5/16, 3/8 AF			
1 pc. each				
1450-1D	145 mm			
		6,3 1/4"		
1450-4	270 mm			
		6,3 1/4"		
1450-5	100 mm			
		6,3 1/4"		
1450-8	45 mm			
		6,3 1/4"		
1450-3	150 mm			
		6,3 1/4"		
1450-16	25 mm			
		6,3 1/4"		
770-L1D	270 mm			
		12,5 1/2"		
770-L3	300 mm			
		12,5 1/2"		
770-L5/L6	125 mm 250 mm			
1 pc. each		12,5 1/2"		
770-L7	75 mm			
		12,5 1/2"		
1080				
1513				
1591				
1543-3				
242KM-125	125 ml			
466A-16,0				
930-205				
960-185				
950-160				
900IS-...	108, 12508			
1 pc. each				
910PH-...	PH1 PH2			
1 pc. each				
564N				
561				
600-IS...	1,2 x 60, 1,5 x 60 2,0 x 60			
610-PH...	00 x 60 0 x 60			
4680-MH E				
4550-F E				
262-150				
265-10				
271-...	3,0, 5,0			
1 pc. each				
246-2x200				
207-2x200				
248-2x200				
189				
1665-500				
1690-30				
3436-S36	Bit-Box 36 pcs.			

WS-5M

TOOL ASSORTMENT

- suitable for tool cabinet ELORA-No. 1100L
- suitable for Roller Tool Cabinet Buddy ELORA-No. 1210-L7, Super Caddy ELORA-No. 1220-L7 and L8, ToolJET ELORA-No. 1225-L7

Code	Number	Contents	Pieces	Weight/g
0000500501100	WS-5M	146 metric tools	1 assortment	28600
100-...	6x7; 8x9; 10x11; 12x13; 14x15; 16x17; 18x19; 20x22; 21x23; 24x27; 25x28; 30x32 mm			
1 pc. each				
110-...	6x7; 8x9; 10x11; 12x13; 14x15; 16x17; 18x19; 20x22; 21x23; 24x27; 25x28; 30x32 mm			
1 pc. each				
205-...	8; 9; 10; 11; 12; 13; 14; 15; 16; 17; 18; 19; 20; 21; 22 mm			
1 pc. each				
770-LM...	10; 11; 12; 13; 14; 15; 16; 17; 18; 19; 21; 22; 23; 24; 25; 26; 27; 30; 32 mm		12,5	1/2"
1 pc. each				
1455-M...	4; 4,5; 5; 5,5; 6; 7; 8; 9; 10; 11; 13 mm		6,3	1/4"
1 pcs. each				
157-11M	4; 4,5; 5; 5,5; 6; 6,5; 7; 7,5 mm			
1 pc. each				
158R-1	2; 2,5; 3; 4; 5; 6; 8; 10 mm			
1 pc. each				
188-13M	0,05; 0,10; 0,15; 0,20; 0,25; 0,30; 0,40; 0,50; 0,60; 0,70; 0,80; 0,90; 1,00			
1 pc. each				
770-L1D	270 mm		12,5	1/2"
770-L2	300 mm		12,5	1/2"
770-L3	300 mm		12,5	1/2"
770-L5/L6	125 mm 250 mm		12,5	1/2"
1 pc. each				
770-L7	75 mm		12,5	1/2"
1450-1D	145 mm		6,3	1/4"
1450-3	150 mm		6,3	1/4"
1450-4	270 mm		6,3	1/4"
1450-5	100 mm		6,3	1/4"
1450-8	270 mm		6,3	1/4"
222-16x20,8	16x20,8 mm			
165-500	500 mm			
2 pcs.				
170-...	170-24x27 mm 170-32x38 mm			
171-500x18	500 mm			
195CV-17	17; 19; 22 mm; 11/16"AF			
60-...	60-6A, 160mm / 6"; 60-8A, 210mm / 8"; 60-10A, 260mm / 10"			
1 pc. each				
480-330	330 mm			
132-...	132-190 mm, 132-240 mm			
500-250	250 mm			
470-BI 200	200 mm			
471-45BI 200	200 mm			
485-BI 165	165 mm			
490-BI 165	165 mm			
495-BI 185	185 mm			
473-J2	180 mm			
473-J21	165 mm			
474-...	A2 A21			
1 pc. each				
242KM-250	250 ccm			
539-IS...	IS 100; 150			
1 pc. each				
545-IS...	IS 75; 100; 150			
1 pc. each				
543-IS 60				
555-PH1				
547-PH...	547-PH 1; PH 2			
1 pc. each				
260	260-150 mm; 260-200 mm			
1 pc. each				
261-150	150 mm			
264-...	264-120x10x3; 120x12x4 ; 120x12x5; 120x12x6 mm			
1 pc. each				
265-10	120x10 mm			
189	420 mm			
1665-300	300 g			
1665-35				
266-K	262-125 mm, 262-150 mm 263-125 mm, 264-120x10x4 mm 264-120x12x4 mm, 265-120x10mm			
246-1x200	200 mm/8"			
247-2x200	200 mm/8"			
248-2x200	200 mm/8"			
352-S6	screw extractor set 350-6; 8; 11; 14; 18; 24			
1 set				

WS-5A

TOOL ASSORTMENT

- suitable for tool cabinet ELORA-No. 1100L
- suitable for Roller Tool Cabinet Buddy ELORA-No. 1210-L7, Super Caddy ELORA-No. 1220-L7 and L8, ToolJET ELORA-No. 1225-L7

Code	Number	Contents	Pieces	Weight/g
0000600501100	WS-5A	151 inch tools	1 assortment	28200
100A-...	1/4x5/16; 5/16x3/8; 3/8 x7/16; 7/16x1/2; 1/2x9/16; 9/16x5/8; 5/8x11/16; 11/16x3/4; 3/4x7/8; 13/16x7/8; 15/16x1; 1.1/16x1.1/4 AF			
1 pc. each				
110A-...	1/4x5/16; 5/16x3/8; 3/8x7/16; 7/16x1/2; 1/2x9/16; 9/16x5/8; 5/8x11/16; 3/4x25/32; 13/16x7/8; 15/16x1; 1x1.1/8; 1.1/16x1.1/4 AF			
1 pc. each				
205A-...	5/16; 3/8; 7/16; 1/2; 9/16; 9/32; 5/8; 11/16; 3/4; 1/4; 13/16; 7/8; 15/16; 1; 1.1/16; 1.1/8; 1.1/4 AF			
1 pc. each				
770-LA...	3/8; 7/16; 1/2; 9/16; 19/32; 5/8; 11/16; 3/4; 25/32; 13/16; 7/8; 15/16; 31/32; 1; 1.1/16; 1.1/8; 1.3/16; 1.1/4 AF		12,5 1/2"	
1 pc. each				
1455-A...	3/16; 7/32; 1/4; 9/32; 5/16; 11/32; 3/8; 7/16; 1/2 AF		6,3 1/4"	
1 pc. each				
157-11A	3/16; 7/32; 1/4; 9/32; 5/16; 11/32; 3/8; 7/16 AF			
1 pc. each				
158R-3	1/16; 5/64; 3/32; 1/8; 5/32; 3/16; 7/32; 1/4 AF			
1 pc. each				
188-13Z	.002; .003; .004; .005; .006; .008; .010; .012; .015; .020; .025; .030; 035			
1 pc. each				
770-L1D	270 mm		12,5 1/2"	
770-L2	300 mm		12,5 1/2"	
770-L3	300 mm		12,5 1/2"	
770-L5/L6	125 mm 250 mm		12,5 1/2"	
1 pc. each				
770-L7	75 mm		12,5 1/2"	
1450-1D	145 mm		6,3 1/4"	
1450-3	150 mm		6,3 1/4"	
1450-4	270 mm		6,3 1/4"	
1450-5	100 mm		6,3 1/4"	
1450-8	270 mm		6,3 1/4"	
222-16x20,8	16x20,8 mm			
165-500	500 mm			
2 pcs.				
170-...	170-24x27 mm 170-32x38 mm			
171-500x18	500 mm			
195CV-17	17; 19; 22 mm; 11/16" AF			
60-...	60-6A, 160mm / 6"; 60-8A, 210mm / 8"; 60-10A, 260mm / 10"			
1 pc. each				
480-330	330 mm			
132-...	132-190 mm, 132-240 mm			
500-250	250 mm			
470-BI 200	200 mm			
471-45-BI 200	200 mm			
485-BI 165	165 mm			
490-BI 165	165 mm			
495-BI 185	185 mm			
473-J2	180 mm			
473-J21	165 mm			
474-...	A2 A21			
1 pc. each				
242KM-250	250 ccm			
539-IS...	IS 100; 150			
1 pc. each				
545-IS...	IS 75; 100; 150			
1 pc. each				
543-IS 60				
555-PH1				
547-PH...	547-PH 1; PH 2			
1 pc. each				
260	260-150 mm; 260-200 mm			
1 pc. each				
261-150	150 mm			
264-...	264-120x10x3; 120x12x4 ; 120x12x5; 120x12x6 mm			
1 pc. each				
265-10	120x10 mm			
189	420 mm			
1665-300	300 g			
1665-35				
266-K	262-125 mm, 262-150 mm 263-125 mm, 264-120x10x4 mm 264-120x12x4 mm, 265-120x10mm			
246-1x200	200 mm/8"			
247-2x200	200 mm/8"			
248-2x200	200 mm/8"			
352-S6	screw extractor set 350-6; 8; 11; 14; 18; 24			
1 set				

WS-6M



TOOL ASSORTMENT

- suitable for tool cabinet ELORA-No. 1100L
- suitable for Roller Tool Cabinet Buddy ELORA-No. 1210-L7, Super Caddy ELORA-No. 1220-L7 and L8, ToolJET ELORA-No. 1225-L7
- suitable for cantilever tool box ELORA-Nr. 810-L
- suitable for hard protective case ELORA-No. 1380-L and hard protective trolley Case ELORA-No. 1381-L
- suitable for installation tool bag ELORA-No. 1385-L

Code	Number	Contents	Pieces	Weight/g
0000500601000	WS-6M	85 metric tools	1 assortment	7800
146-...	4, 4,5, 5, 5,5, 6, 7, 8, 9, 10, 11, 12, 13, 14, 17 mm			
1 pc. each				
113-...	4x4,5, 5x5,5, 6x7, 8x9, 10x11 mm			
1 pc. each				
1455-M...	4, 4,5, 5, 5,5, 6, 7, 8, 9, 10, 11, 12, 13, 14 mm	6,3 1/4"		
1 pc. each				
158-R1	2; 2,5; 3; 4; 5; 6; 8; 10 mm			
1 pc. each				
216-...	4, 4,5, 5, 5,5, 6, 7, 8, 9, 10 mm			
1 pc. each				
1450-1D	145 mm	6,3 1/4"		
1450-3	150 mm	6,3 1/4"		
1450-4	270 mm	6,3 1/4"		
1450-5	100 mm	6,3 1/4"		
1450-8	45 mm	6,3 1/4"		
131BI-240				
476-BI...	145 170			
1 pc. each				
477-BI...	145 170			
1 pc. each				
490-BI 165				
494-BI 160				
495-BI 165				
900IS-...	75, 100, 7506, 108, 12510	GS DVE 1000 V		
1 pc. each				
910PH-...	PH0 PH1 PH2	GS DVE 1000 V		
1 pc. each				
242K-60	60 ml			
237-500				
1665-100				
566-150		GS DVE 1000 V		
1591-250				
257A				
740-...	4,0 5,5 8,0	GS DVE 1000 V		
1 pc. each				
730-...	1 + 3	GS DVE 1000 V		
1 pc. each				
271-...	2, 3, 4, 5			
1 pc. each				

WS-9M
TOOL ASSORTMENT

- suitable for tool cabinet ELORA-No. 1100L
- suitable for Roller Tool Cabinet Buddy ELORA-No. 1210-L7, Super Caddy ELORA-No. 1220-L7 and L8, ToolJET ELORA-No. 1225-L7
- suitable for cantilever tool box ELORA-Nr. 810-L
- suitable for hard protective case ELORA-No. 1380-L and hard protective trolley Case ELORA-No. 1381-L
- suitable for Installation tool bag ELORA-No. 1385-L
- suitable for cantilever tool box ELORA-Nr. 800-L, 810-L, 803-L, 813-L

Code	Number	Contents	Pieces	Weight/g
0000500901000	WS-9M	48 metric tools	1 assortment	5300
203-...	6, 7, 8, 10, 13, 15, 17, 19 mm			
1 pc. each				
159-S-KK-1	2,5, 3, 4, 5, 6, 8 mm			
1 pc. each				
770-LM...	10, 11, 12, 13, 14, 15, 16, 17, 18, 19, 20, 22	 12,5 1/2"		
1 pc. each				
251				
561		 		
586				
132-240				
1665-200				
260-150				
265-10				
271-4				
321-180				
470-BI200				
490-BI 165				
495-BI 185				
545-IS...	75, 100, 125, 150			
1 pc. each				
547-...	PH1 PH2			
1 pc. each				
770-L1D	270 mm			12,5 1/2"
770-L3	300 mm			12,5 1/2"
770-L6	250 mm			12,5 1/2"
771-LTZ 20,8				12,5 1/2"

WS-8M

PLUMBING TOOL SET

01

- suitable for tool cabinet ELORA-No. 1100L
- suitable for Roller Tool Cabinet Buddy ELORA-No. 1210-L7, Super Caddy ELORA-No. 1220-L7 and L8, ToolJET ELORA-No. 1225-L7
- suitable for cantilever tool Box ELORA-Nr. 810-L
- suitable for hard protective case ELORA-No. 1380-L and hard protective trolley case ELORA-No. 1381-L
- suitable for cantilever tool box ELORA-Nr. 810-L

Code	Number	Contents	Pieces	Weight/g
0000500811001	WS-8M	59 metric tools	1 assortment	15000
121-...	8x10, 9x11, 12x14, 13x15, 14x16, 17x19, 21x23, 22x24 mm			
1 pc. each				
204-...	10, 11, 12, 13, 14, 15, 16, 17, 18, 19, 22, 24 mm			
1 pc. each				
159-...	1,5, 2, 2,5, 3, 4, 5, 6, 8, 10, 12 mm			
770-L1ZI	250 mm	12,5 1/2"		
539-IS...	100, 125, 150			
1 pc. each				
559-PH...	PH1 PH2			
1 pc. each				
468-BI				
470-BI 165				
60-12MB				
68SN-1.1/2				
132-240				
301-250				
181				
138				
137				
1665-500				
65-2				
179-16				
180-35				
64				
182-42				
365-200x8x10				
362-250				
283HS				
1544H				
561				
189P				
281-90				
1672-1250				
484R-260				
139-100				

WS-8A
PLUMBING TOOL SET

- suitable for tool cabinet ELORA-No. 1100L
- suitable for Roller Tool Cabinet Buddy ELORA-No. 1210-L7, Super Caddy ELORA-No. 1220-L7 and L8, ToolJET ELORA-No. 1225-L7
- suitable for cantilever tool Box ELORA-Nr. 810-L
- suitable for hard protective case ELORA-No. 1380-L and hard protective trolley case ELORA-No. 1381-L
- suitable for cantilever tool box ELORA-Nr. 810-L

Code	Number	Contents	Pieces	Weight/g
0000600811001	WS-8A	57 inch tools	1 assortment	15000
121-...	5/16x3/8, 7/16x1/2, 9/16x5/8, 5/8x3/4, 3/4x7/8, 1x1.1/8 AF			
1 pc. each				
204A-...	5/16, 3/8, 7/16, 1/2, 9/16, 5/8, 11/16, 3/4, 13/16, 7/8, 15/16, 1 AF			
1 pc. each				
159A-...	1/16, 5/64, 3/32, 1/8, 5/32, 3/16, 7/32, 1/4, 5/16, 3/8 AF			
770-L1ZI	250 mm	12,5 1/2"		
539-IS...	100, 125, 150			
1 pc. each				
559-PH...	PH1 PH2			
1 pc. each				
468-BI				
470-BI 165				
60-12MB				
68SN-1.1/2				
132-240				
301-250				
181				
138				
137				
1665-500				
65-2				
179-16				
180-35				
64				
182-42				
365-200x8x10				
362-250				
283HS				
1544H				
561				
189P				
281-90				
1672-1250				
484R-260				
139-100				

WS-10M

ELECTRICIAN TOOL SET

- suitable for tool cabinet ELORA-No. 1100L
- suitable for Roller Tool Cabinet Buddy ELORA-No. 1210-L7, Super Caddy ELORA-No. 1220-L7 and L8, ToolJET ELORA-No. 1225-L7
- suitable for cantilever tool box ELORA-Nr. 810-L
- suitable for hard protective case ELORA-No. 1380-L and hard protective trolley case ELORA-No. 1381-L
- suitable for installation tool bag ELORA-No. 1385-L
- suitable for cantilever tool box ELORA-Nr. 810-L

Code	Number	Contents	Pieces	Weight/g
0000501101001	WS-10M	75 metric tools	1 assortment	5800
100-...	14x17, 18x19, 21x23, 22x24			
1 pc. each				
146-...	4, 4,5, 5, 5,5, 6, 7, 8, 9, 10, 11, 12, 13 mm			
1 pc. each				
159-...	1,5, 2, 2,5, 3, 4, 5, 6, 8, 10, 12 mm			
1 pc. each				
1455-M...	4, 4,5, 5, 5,5, 6, 7, 8, 9, 10, 11, 13 mm			
1 pc. each			6,3	1/4"
1450-1D	145 mm			
			6,3	1/4"
1450-4	270 mm			
			6,3	1/4"
1450-5	100 mm			
			6,3	1/4"
1450-8	45 mm			
			6,3	1/4"
1450-3	150 mm			
			6,3	1/4"
543-IS 60				
555-PH1				
549-PZ...	PZ1, PZ2			
1 pc. each				
730-1				
740-...	5,5, 8,0			
1 pc. each				
910PH-...	PH1, PH2			
1 pc. each				
900IS-...	106, 108, 12508, 150			
1 pc. each				
563				
960-185				
930-165				
920-165				
935-45				
970-160				
61-MB 10				
260-175				
264-...	264-120x10x2 mm, 264-120x10x4 mm			
1 pc. each				
265-10				
365-250x10x15				
1665-300				
132-240				
257-50				
257-S	saw blade, universal			
746				
1591-250				
281				
1546-3				
498-1				

WS-10A
ELECTRICIAN TOOL SET

- suitable for tool cabinet ELORA-No. 1100L
- suitable for Roller Tool Cabinet Buddy ELORA-No. 1210-L7, Super Caddy ELORA-No. 1220-L7 and L8, ToolJET ELORA-No. 1225-L7
- suitable for cantilever tool box ELORA-Nr. 810-L
- suitable for hard protective case ELORA-No. 1380-L and hard protective trolley case ELORA-No. 1381-L
- suitable for installation tool bag ELORA-No. 1385-L
- suitable for cantilever tool box ELORA-Nr. 810-L

Code	Number	Contents	Pieces	Weight/g
0000601101001	WS-10A	75 inch tools	1 assortment	5800
100A-...	9/16x5/8, 11/16x3/4, 13/16x7/8, 15/16x1 AF			
1 pc. each				
146A-...	5/32, 3/16, 7/32, 9/32, 5/16, 11/32, 3/8, 15/32, 7/16, 1/2, 9/16, 5/8 AF			
1 pc. each				
159A-...	1/16, 5/64, 3/32, 1/8, 5/32, 3/16, 7/32, 1/4, 5/16, 3/8 AF			
1 pc. each				
1455-A-...	3/16, 7/32, 1/4, 9/32, 5/16, 11/32, 3/8, 7/16, 1/2 AF			
1 pc. each		6,3 1/4"		
1450-1D	145 mm			
		6,3 1/4"		
1450-4	270 mm			
		6,3 1/4"		
1450-5	100 mm			
		6,3 1/4"		
1450-8	45 mm			
		6,3 1/4"		
1450-3	150 mm			
		6,3 1/4"		
543-IS 60				
555-PH1				
549-PZ-...	PZ1, PZ2			
1 pc. each				
730-1				
740-...	5,5, 8,0			
1 pc. each				
910PH-...	PH1, PH2			
1 pc. each				
900IS-...	106, 108, 12508, 150			
1 pc. each				
563				
960-185				
930-165				
920-165				
935-45				
970-160				
61-MB 10				
260-175				
264-...	264-120x10x2 mm, 264-120x10x4 mm			
1 pc. each				
265-10				
365-250x10x15				
1665-300				
132-240				
257-50				
257-S	saw blade, universal			
746				
1591-250				
281				
1546-3				
498-1				

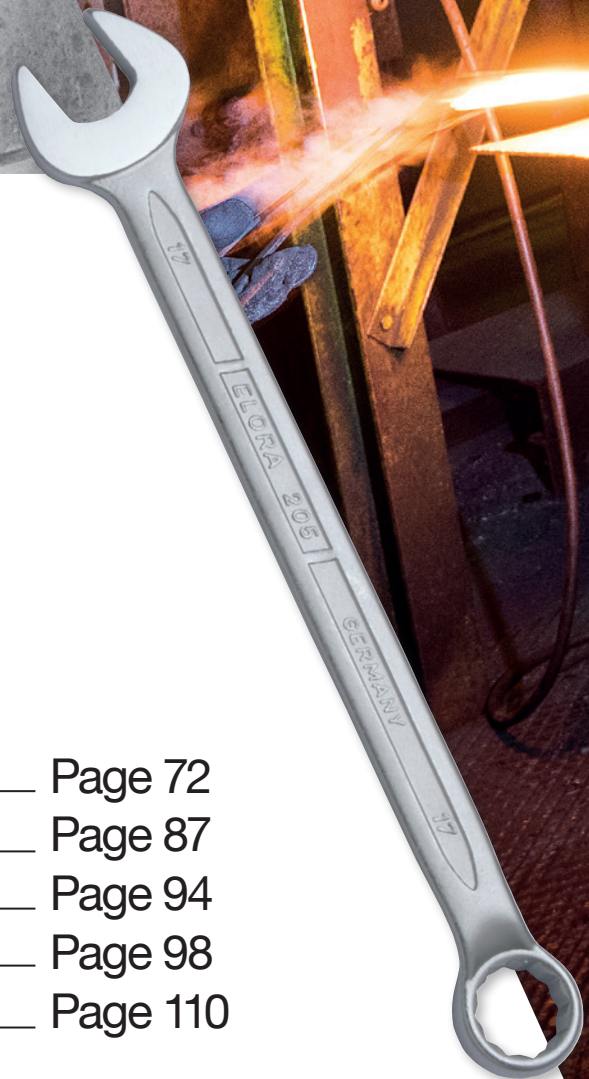

SPANNERS

Combination spanners _____	Page 72
Open ended spanners _____	Page 87
Hook and DIN spanners _____	Page 94
Ring- and double ended ring spanners _____	Page 98
Slogging and construction _____	Page 110
ring spanners	
Hexagon tubular box spanners _____	Page 115