



The ELORA team consists of much more than just 11 field players, who are loyal to us far longer than the standard set in professional soccer. But, of course, we are also passionate about success, technology and team spirit.

1510

VERNIER CALIPER

- in case
- for inside, outside and depth measurement
- reading by vernier scale 0,05 mm respectively 1/128"
- jaw length 40 mm respectively 1.57 inch
- with locking screw
- matt chrome plated



Code	Number	Measuring range mm	Measuring range Inch	Pieces	Weight/g
151000000000	1510	150	6	1	223

1511

POCKET Vernier CALIPER

- in case
- for inside, outside and depth measurement
- reading by vernier scale 0,05 mm respectively 1/128"
- jaw length 40 mm respectively 1.57 inch
- with thumb lock
- matt chrome plated

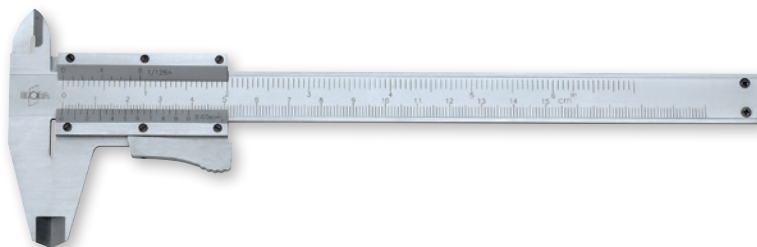

Code	Number	Measuring range mm	Measuring range Inch	Pieces	Weight/g
1511001500000	1511	150	6	1	230

1512

PRECISION Vernier CALIPER

- in case
- for inside, outside and depth measurement (4 way measurement)
- reading by vernier scale 0,05 mm respectively 1/128"
- jaw length 40 mm respectively 1.57 inch
- with thumb lock
- matt chrome plated reading parts
- thread table on the back
- stainless steel
- DIN 862



Code	Number	Measuring range mm	Measuring range Inch	Pieces	Weight/g
1512000000000	1512	150	6	1	234

1513

PRECISION Vernier CALIPER

- in case
- for inside, outside and depth measurement (4 way measurement)
- reading by vernier scale 0,05 mm respectively 1/128"
- jaw length 40 mm respectively 1.57 inch
- with thumb lock
- matt chrome plated reading parts
- thread table on the back
- stainless steel
- DIN 862



Code	Number	Measuring range mm	Measuring range Inch	Pieces	Weight/g
1513000000000	1513	150	6	1	220

1520-...

WORKSHOP CALIPER

- for inside, outside measurement
- reading by vernier scale 0,05 mm respectively 1/128"
- with stepped jaws, knife points and locking screw
- matt chrome plated reading parts
- thread table on the back
- stainless steel
- DIN 862



Code	Number	Measuring range mm	Measuring range Inch	Jaws mm	Jaws Inch	Pieces	Weight/g
1520002002000	1520-200	200	8	80	3,2	1	519
1520002502000	1520-250	250	10	80	3,2	1	610
1520003002000	1520-300	300	12	90	3,5	1	687

1522-300

WORKSHOP CALIPER

- in case
- for inside, outside measurement
- reading by vernier scale 0,05 mm respectively 1/128"
- with stepped jaws, knife points, fine adjustment and locking screw
- matt chrome plated reading parts
- thread table on the back
- stainless steel
- DIN 862



Code	Number	Measuring range mm	Measuring range Inch	Jaws mm	Jaws Inch/Inch	Pieces	Weight/g
1522003001000	1522-300	300	12	100	4	1	761

1515-...

PRECISION DIAL CALIPER

- in plastic case
- for inside, outside and depth measurement (4 way measurement)
- 1515-50: reading 0,02 mm
- 1515-100: reading 0,01 mm
- jaw length 40 mm respectively 1,57 inch
- fine adjustment scroll, locking screw
- stainless steel
- DIN 862



Code	Number	Measuring range mm	Measuring range Inch/Inch	Reading mm	Pointer Rotation mm	Pieces	Weight/g
1515000500000	1515-50	150	6	0,02 = 1/50	2	1	388
1515001000000	1515-100	150	6	0,01 = 1/100	1	1	373

1517-...

DIGITAL VERNIER CALIPER

- packed in a plastic bag
- reading 0,01 mm
- pattern with depth measurement and locking screw
- 10 mm LCD-Display
- Stainless steel
- DIN 862

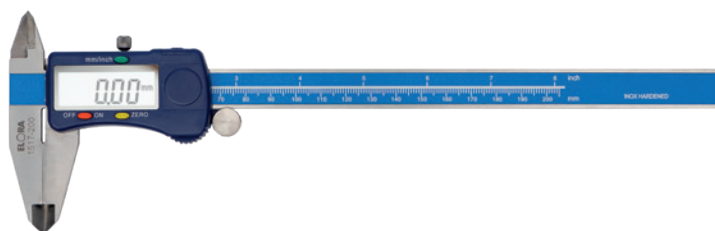

Code	Number	Measuring range mm	Measuring range Inch	Jaws mm	Jaws Inch	Pieces	Weight/g
1517001500000	1517-150	150	6	40	1,6	1	364
1517002000000	1517-200	200	8	50	2,0	1	501
1517003000000	1517-300	300	12	60	2,4	1	801
1517040000000	1517-B	Spare Battery				1	3

1519

BRASS POCKET CALIPER

- in case
- reading by vernier scale 0,1 mm respectively 1/16"
- 20 mm jaw length
- hard brass

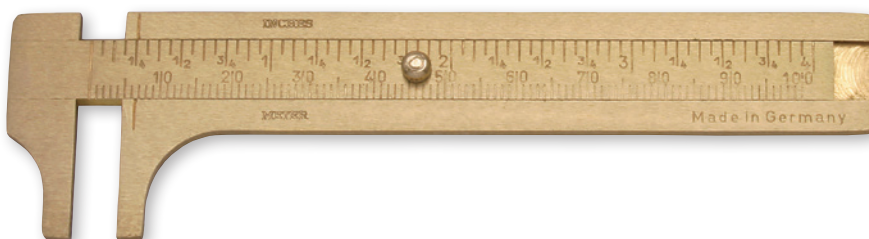

Code	Number	Measuring range mm	Measuring range Inch	Pieces	Weight/g
1519000000000	1519	100	4	1	66

1523

PRECISION VERNIER CALIPER FOR BRAKE DISCS

- carton box packed
- 1/20 mm (reading of 0,05mm) and 1/128" vernier scale
- pattern with trailing vernier and locking screw
- vernier matt chromed
- stainless steel

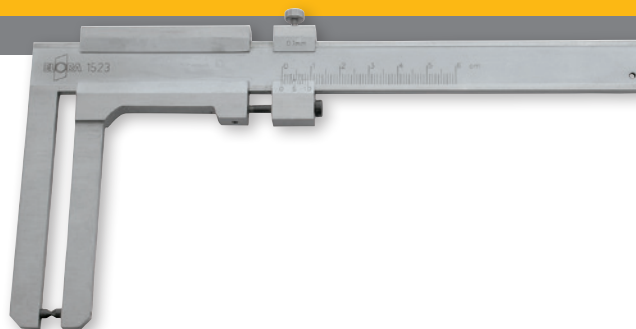

Code	Number	Measuring range mm	Measuring range Inch	Jaws mm	Jaws Inch	Pieces	Weight/g
1523000000000	1523	60	2,4	80	3,2	1	303

1524-...

PRECISION DEPTH VERNIER CALIPER

- in wooden case
- for depth measurement
- reading by vernier scale 0,05 mm
- anti-glare with locking screw
- stainless steel
- DIN 862

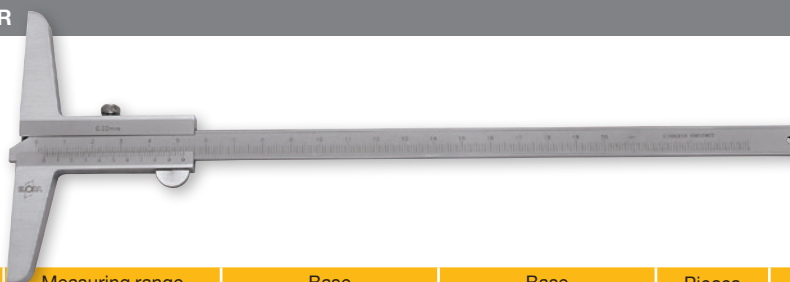

Code	Number	Measuring range mm	Measuring range Inch	Base mm	Base Inch	Pieces	Weight/g
1524002001000	1524-200	200	8	100	4	1	135
1524003001000	1524-300	300	12	100	4	1	280

1530-...

PRECISION OUTSIDE MICROMETER

- in wooden case
- reading 0,01 mm
- pitch 0,5 mm
- matt chrome plated reading parts
- with locking lever, friction coupling and adjustable scale sleeve
- setting standard from ELORA No. 1530-50 upwards
- carbide tipped measuring surfaces
- DIN 863

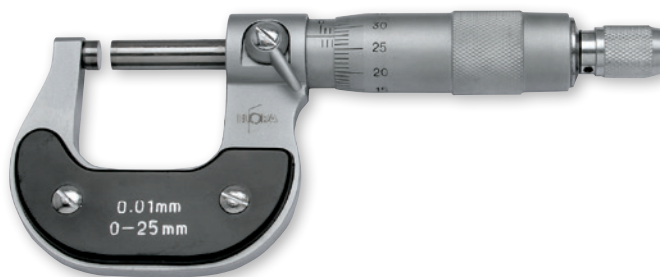

Code	Number	Measuring range mm	Pieces	Weight/g
1530000251000	1530-25	0-25	1	300
1530000501000	1530-50	25-50	1	480
1530000751000	1530-75	50-75	1	640
1530001001000	1530-100	75-100	1	820

1530S4

PRECISION OUTSIDE MICROMETRE SET

- in wooden case
- reading 0,01 mm
- pitch 0,5 mm
- matt chrome plated reading parts
- with locking lever, friction coupling and adjustable scale sleeve
- setting standard from ELORA No. 1530-50 upwards
- carbide tipped measuring surfaces
- DIN 863



Code	Number	Contents	Pieces	Weight/g
1530501001000	1530S4	Precision-Micrometer 1530-25 Measuring range 0-25 mm 1530-50 Measuring range 25-50 mm 1530-75 Measuring range 50-75 mm 1530-100 Measuring range 75-100 mm	1	2140

1532-...

PRECISION INTERNAL MICROMETER

- in plastic storage case
- reading 0,01 mm
- including inspection gauges
- matt chrome plated reading parts
- friction coupling and locking screw



Code	Number	Measuring range mm	Pieces	Weight/g
1532000051000	1532-5	5-30	1	288
1532000251000	1532-25	25-50	1	356
1532000501000	1532-50	50-75	1	346

1535-...

PROTRACTOR

- for measurement of angular degrees 0 – 180°
- with locking screw
- special steel matt chrome plated



Code	Number	Ø of protractor mm	Ø of protractor Inch	Length of rail mm	Length of rail Inch	Pieces	Weight/g
1535000801000	1535-80	80	3,2	120	4,8	1	92
1535001201000	1535-120	120	4,8	150	6	1	158
1535001501000	1535-150	150	6	200	8	1	236
1535002001000	1535-200	200	8	300	12	1	464
1535002501000	1535-250	250	10	500	20	1	560
1535003001000	1535-300	300	12	600	24	1	1319

1537-...

PROTRACTOR

- packed in a plastic bag
- for measurement of angular degrees 10-170°
- pattern with moveable rail and locking screw
- matt chrome plated



Code	Number	Ø of protractor mm	Ø of protractor Inch	Length of rail mm	Length of rail Inch	Pieces	Weight/g
1537001001000	1537-100	100	4	150	6	1	187
1537001501000	1537-150	150	6	300	12	1	427
1537002001000	1537-200	200	8	400	16	1	647

1541-...

UNIVERSAL BEVEL WITH MAGNIFIER

- in plastic case
- 1/12° respectively 5°
- circle graduation 4 x 90°
- hardened rail
- with locking screw
- matt chrome plated reading parts
- stainless steel



Code	Number	l/mm	l/Inch	Pieces	Weight/g
1541002001000	1541-200	200	8	1	628
1541003001000	1541-300	300	12	1	654

1544H

FOLDING RULE

- reading 1 mm
- according to accuracy class III of the EC regulation
- hinges made of epoxy lacquered steel
- with hidden rivet
- beech wood

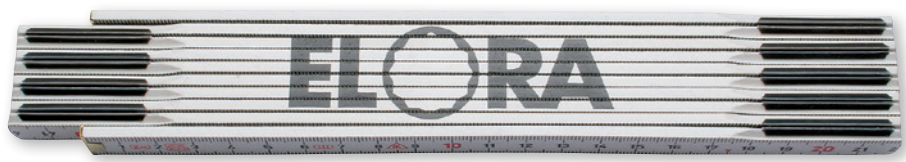

Code	Number	Length m	Pieces	Weight/g
1544000028000	1544H	2	6	125

1546-...

MEASURING TAPE

- according to precision class II
- measuring tape corresponds to EU-directive 2014/32/EU, i.e. it is CE-marked and due to this initially calibrated
- partitioning 1 mm
- automatic strip-intake with return stop
- with one-sided double scale
- gliding end hook, double riveted
- with belt clip
- curved, kink resistant measuring tape
- handy 2 component housing made of high-strength ABS plastic
- measuring tape made of 65Mn spring steel, yellow
- with nylon coat, ensuring abrasion resistance and anticorrosive coating



Code	Number	Length of tape m	Width of tape mm	l/mm	Pieces	Weight/g
1546000030000	1546-3	3	16	60,8	1	116
1546000050000	1546-5	5	19	70,9	1	223
1546000080000	1546-8	8	25	83,0	1	430
1546000100000	1546-10	10	25	92,1	1	492

1546XL-...

MEASURING TAPE

- according to precision class II
- measuring tape corresponds to EU-directive 2014/32/EU, i.e. it is CE-marked and due to this initially calibrated
- with warp resistant, light A-frame
- with tangential tape extraction for protection against deformation of the tape
- ergonomic grip design
- steal measuring tape, white lacquered and sealed with transparent UV-lacquer
- protection against subsurface corrosion by zinc phosphating
- one-sided partitioning mm
- start A (measure starts approx. 10 cm behind the fitting) with plastic ring
- roll-up mechanism running on a steel shaft with high plain bearings effect



Code	Number	Length of tape m	Width of tape mm	l/mm	Pieces	Weight/g
1546000302000	1546XL-30	30	13	320	1	780
1546000502000	1546XL-50	50	13	350	1	1200

1545-...

FLEXIBLE STEEL RULE

- ▶ according to accuracy class II of the EC regulation
- ▶ graduation in mm
- ▶ stainless spring band steel



Code	Number	Measurement mm	Pieces	Weight/g
1545001501000	1545-150	150 × 13 × 0,5	6	10
1545002001000	1545-200	200 × 13 × 0,5	6	10
1545003001000	1545-300	300 × 13 × 0,5	6	20
1545005001000	1545-500	500 × 20 × 0,5	1	47
1545010001000	1545-1000	1000 × 20 × 0,5	1	84

1547-...

FLEXIBLE STEEL RULE

- ▶ according to accuracy class II of the EC regulation
- ▶ graduation in mm
- ▶ stainless spring band steel



Code	Number	Measurement mm	Pieces	Weight/g
1547003001000	1547-300	300 × 30 × 1,0	6	60
1547005001000	1547-500	500 × 30 × 1,0	1	130
1547010001000	1547-1000	1000 × 30 × 1,0	1	270

1552-...

ALUMINIUM RULER

- ▶ graduation in mm
- ▶ pattern with touching edge and anodized surface
- ▶ aluminium alloy



Code	Number	Measurement mm	Pieces	Weight/g
1552003001000	1552-300	300 × 50 × 5	1	190
1552006001000	1552-600	600 × 50 × 5	1	365
1552010001000	1552-1000	1000 × 50 × 5	1	605

1582-...

MARKING GAUGE WITH FLAT SLIDER

- ▶ for precise measurement by stop on the work piece
- ▶ graduation in mm
- ▶ flat pattern with hardened marking edge and locking screw
- ▶ matt chrome plated
- ▶ factory norm



Code	Number	l/mm	l/Inch	Pieces	Weight/g
1582002001000	1582-200	200	8	1	421
1582002501000	1582-250	250	10	1	467
1582003001000	1582-300	300	12	1	586

1553-...

PRECISION STRAIGHT-EDGE RULER

- in case
- accuracy class 00
- for checking the evenness of surfaces
- through hardened, measuring surfaces lapped
- handle insulated as isolation against hand warm
- high grade tool steel
- DIN 874



Code	Number	Measurement mm	Measurement Inch	Pieces 	Weight/g
1553001001000	1553-100	100	4	1	81
1553001501000	1553-150	150	6	1	150
1553002001000	1553-200	200	8	1	245
1553003001000	1553-300	300	12	1	622
1553005001000	1553-500	500	20	1	1756



1554-...

SPIRIT LEVEL

- accuracy: 0,5 mm/m = 0,029°
- with unbreakable vials made of acrylic glass
- horizontal vials with magnifying lens
- lateral mm graduation
- rectangular aluminium profile (50 x 21 mm), surface plastic coated



Code	Number	l/mm	l/Inch	Pieces	Weight/g
1554004000000	1554-400	400	16	1	353
1554006000000	1554-600	600	24	1	443
1554008000000	1554-800	800	32	1	555
1554010000000	1554-1000	1000	40	1	687

1555

PRECISION DIAL INDICATOR

- in plastic storage case
- clamping shank 8h6 diameter
- adjustable tolerance marks
- housing made of stainless steel



Code	Number	Measuring range mm	Reading mm	Outside Ø mm	Pieces	Weight/g
1555000000000	1555	0-10	0,01	58	1	274

1557

PRECISION DIAL MINI INDICATOR

- in plastic storage case
- clamping shank 8h6
- adjustable tolerance marks
- housing made of stainless steel



Code	Number	Measuring range mm	Reading mm	Outside Ø mm	Pieces	Weight/g
1557000000000	1557	0-5	0,01	40	1	143

1565

UNIVERSAL MAGNETIC DIAL GAUGE STAND

- for holding dial indicators ELORA-No. 1555 and 1557
- on / off switching for activation of the magnetic stand (65 x 50 x 55 mm) with an adhesive force of 600N
- Ø 8 mm dial indicator holding hole
- vertical bar 230 mm, horizontal bar 200 mm
- leverage hard chrome plated with fine adjustment



Code	Number	l/mm	Pieces	Weight/g
1565000000000	1565	280	1	1864

1566GU-...

JOINER'S SQUARE

- short steel side 20 mm
- try square with mitre
- long steel side with 2 scales
- short steel side made of die cast metal

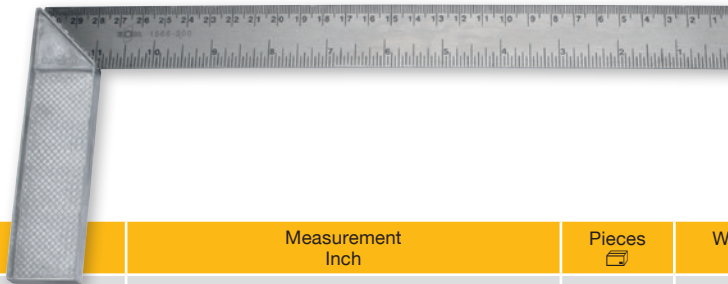

Code	Number	Measurement mm	Measurement Inch	Pieces	Weight/g
1566002501000	1566GU-250	250	10	6	140
1566003001000	1566GU-300	300	12	6	150

1566H-...

JOINER'S SQUARE

- try square with mitre
- long steel side with 2 scales
- short side made of beech wood with brass fittings

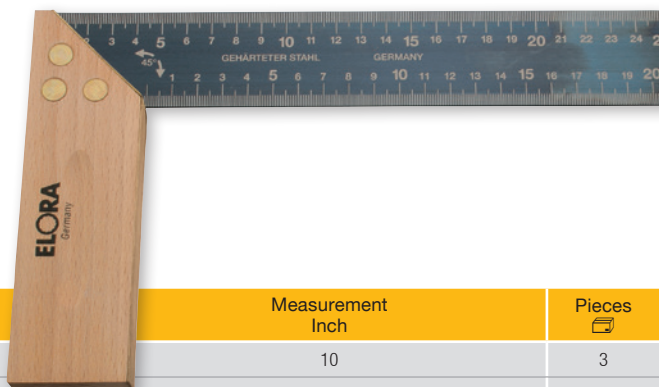

Code	Number	Measurement mm	Measurement Inch	Pieces	Weight/g
1566012501000	1566H-250	250	10	3	170
1566013001000	1566H-300	300	12	3	200
1566014001000	1566H-400	400	16	3	270

1567GU-...

JOINER'S SLIDING BEVEL

- with locking screw
- leg made of die cast metal, tongue made of hardened steel



Code	Number	Measurement mm	Measurement Inch	Pieces	Weight/g
1567002501000	1567GU-250	250	10	6	285
1567003001000	1567GU-300	300	12	6	320

1567H-...

JOINER'S SLIDING BEVEL

- with locking screw
- side made of beech wood with brass fittings
- blue hardened steel blade



Code	Number	Measurement mm	Measurement Inch	Pieces	Weight/g
1567012001000	1567H-200	200	8	6	110
1567012501000	1567H-250	250	10	6	130
1567013001000	1567H-300	300	12	6	150

1569-...

PRECISION STEEL SQUARE

- accuracy class 00
- long side with knife edges on both sides
- measuring surface lapped
- high-tensile steel, through hardened
- DIN 875



Code	Number	Measurement mm	Pieces	Weight/g
1569000501000	1569-50	50 x 40	1	35
1569000751000	1569-75	75 x 50	1	60
1569001001000	1569-100	100 x 70	1	126
1569001501000	1569-150	150 x 100	1	293

1570-.../1571-...

ENGINEER STEEL SQUARE

- 1570: 90° plain blade without stop
- 1571: 90° blade with stop
- with exposed try square
- zinc coated
- steel



Code	Number	Measurement mm	Pieces	Weight/g
1570001001000	1570-100	100 x 70	6	70
1570001501000	1570-150	150 x 100	6	150
1570002001000	1570-200	200 x 130	6	250
1570002501000	1570-250	250 x 160	6	350
1570003001000	1570-300	300 x 180	6	400
1570004001000	1570-400	400 x 230	6	575
1570005001000	1570-500	500 x 280	6	770
1570006001000	1570-600	600 x 330	1	1000
1570007501000	1570-750	750 x 380	1	1200
1570010001000	1570-1000	1000 x 500	1	1850
1571001001000	1571-100	100 x 70	4	105
1571001501000	1571-150	150 x 100	4	235
1571002001000	1571-200	200 x 130	4	350
1571002501000	1571-250	250 x 160	4	475
1571003001000	1571-300	300 x 180	2	550
1571004001000	1571-400	400 x 230	2	800
1571005001000	1571-500	500 x 280	2	1100
1571006001000	1571-600	600 x 330	1	1380
1571007501000	1571-750	750 x 380	1	1660
1571010001000	1571-1000	1000 x 500	1	2220

1577-...

PRECISION CENTER SQUARE

- for scribing the centre of round components
- rail with mm graduation
- matt chrome plated
- factory norm

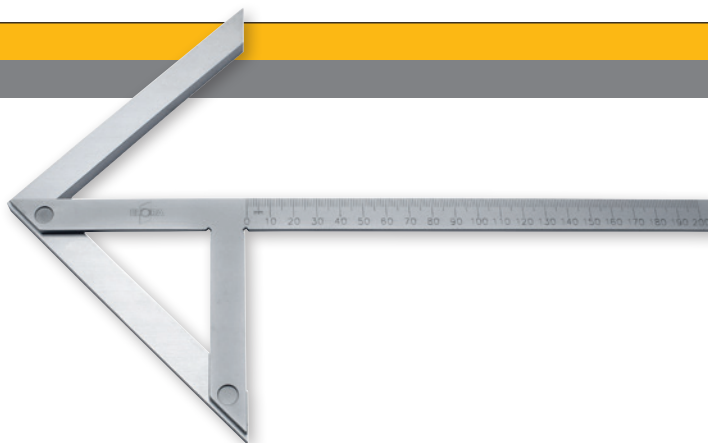

Code	Number	Measurement mm	Cross Section mm	90° Angle mm	Pieces	Weight/g
1577001501000	1577-150	150 x 130	16 x 5	9 x 11	1	477
1577002001000	1577-200	200 x 150	18 x 5	9 x 19	1	581

1578-...

FLANGE STEEL SQUARE

- for alignment off flanges
- zinc coated
- steel
- factory norm



Code	Number	Measurement mm	Flange width mm	Pieces	Weight/g
1578003001000	1578-300	300 x 300	100 x 65	1	912
1578004001000	1578-400	400 x 400	125 x 70	1	1140
1578005001000	1578-500	500 x 500	125 x 70	1	1440
1578006001000	1578-600	600 x 600	125 x 100	1	1600

1579-...

METRE SQUARE 135°

- with stop
- zinc coated
- special steel



Code	Number	Measurement mm	Pieces	Weight/g
1579001501000	1579-150	150 x 100	1	298
1579002001000	1579-200	200 x 130	1	400

188-...M, 188-...Z

FEELER GAUGE

- standard pattern with protection grip
- retractable blades
- blade length 100 mm
- conical blades
- spring band steel



Code	Number	Thickness mm	Pieces	Weight/g	Code	Number	Thickness Inch	Pieces	Weight/g
0188000804000	188-8M	0,05, 0,10, 0,15, 0,20, 0,25, 0,30, 0,40, 0,50	10	35	0188011004000	188-11Z	.0015, .002, .003, .004, .006, .008, .010, .012, .015, .020, .025	10	38
0188000814000	188-81M	0,03, 0,04, 0,05, 0,06, 0,07, 0,08, 0,09, 0,10	10	22	0188013004000	188-13Z	.002, .003, .004, .005, .006, .008, .010, .012, .015, .020, .025, .030, .035	10	52
0188001304000	188-13M	0,05, 0,10, 0,15, 0,20, 0,25, 0,30, 0,40, 0,50, 0,60, 0,70, 0,80, 0,90, 1,00	10	68	0188020004000	188-20Z	.002, .003, .004, .005, .006, .007, .008, .009, .010, .011, .012, .013, .014, .016, .018, .020, .022, .024, .030, .035	10	74
0188002004000	188-20M	0,05, 0,10, 0,15, 0,20, 0,25, 0,30, 0,35, 0,40, 0,45, 0,50, 0,55, 0,60, 0,65, 0,70, 0,75, 0,80, 0,85, 0,90, 0,95, 1,00	10	106	0188022004000	188-22Z	.004, .005, .006, .007, .008, .009, .010, .011, .012, .013, .014, .015, .016, .017, .018, .019, .020, .021, .022, .023, .024, .025	10	85
0188002014000	188-201M	0,05, 0,10, 0,20, 0,30, 0,40, 0,50, 0,60, 0,70, 0,80, 0,90, 1,00, 1,10, 1,20, 1,30, 1,40, 1,50, 1,60, 1,70, 1,80, 1,90, 2,00	10	185	0188026004000	188-26Z	.0015, .002, .0025, .003, .004, .005, .006, .007, .008, .009, .010, .011, .012, .013, .014, .015, .016, .017, .018, .019, .020, .021, .022, .023, .024, .025	10	86
0188002104000	188-21M	0,10, 0,12, 0,14, 0,16, 0,18, 0,20, 0,22, 0,24, 0,26, 0,28, 0,30, 0,32, 0,34, 0,36, 0,38, 0,40, 0,42, 0,44, 0,46, 0,48, 0,50	10	70					
0188002604000	188-26M	0,03, 0,04, 0,05, 0,06, 0,07, 0,08, 0,09, 0,10, 0,15, 0,20, 0,25, 0,30, 0,35, 0,40, 0,45, 0,50, 0,55, 0,60, 0,65, 0,70, 0,75, 0,80, 0,85, 0,90, 0,95, 1,00	10	104					

188MZ-25

FEELER GAUGE

- 25 pcs.
- double marked (mm, AF)
- standard pattern with protection grip
- retractable blades
- blade length 100 mm
- conical blades
- spring band steel



Code	Number	Thickness mm	Thickness Inch	Pieces	Weight/g
0188000004000	188MZ-25	0,04, 0,05, 0,08, 0,10, 0,12, 0,15, 0,18, 0,20, 0,22, 0,25, 0,28, 0,30, 0,33, 0,35, 0,38, 0,40, 0,43, 0,45, 0,50, 0,55, 0,63, 0,75, 0,80, 0,88, 1,00	0,0015, 0,0020, 0,0030, 0,0040, 0,0050, 0,0060, 0,0070, 0,0080, 0,0090, 0,0100, 0,0110, 0,0120, 0,0130, 0,0140, 0,0150, 0,0160, 0,0170, 0,0180, 0,0200, 0,0220, 0,0250, 0,0300, 0,0320, 0,0350, 0,0400	10	86

188R-...

FEELER GAUGE, STAINLESS STEEL

- 188R-13M: 13 pcs.
- 188R-20M: 20 pcs.
- standard pattern with protection grip
- retractable blades
- blade length 100 mm
- conical blades
- stainless steel



Code	Number	Thickness mm	Pieces	Weight/g
0188500134000	188R-13M	0,05, 0,10, 0,15, 0,20, 0,25, 0,30, 0,40, 0,50, 0,60, 0,70, 0,80, 0,90, 1,00	10	60
0188500204000	188R-20M	0,05, 0,10, 0,15, 0,20, 0,25, 0,30, 0,35, 0,40, 0,45, 0,50, 0,55, 0,60, 0,65, 0,70, 0,75, 0,80, 0,85, 0,90, 0,95, 1,00	10	95

194-...

NOZZLE GAUGE

- 194-20M: 20 pcs.
- 194-16M: 16 pcs.
- polished precision pins
- high grade tool steel



Code	Number	Gauge Ø mm	l/mm	Pieces	Weight/g
0194500204000	194-20M	0,45, 0,50, 0,55, 0,60, 0,65, 0,70, 0,75, 0,80, 0,85, 0,90, 0,95, 1,00, 1,05, 1,10, 1,15, 1,20, 1,25, 1,30, 1,40, 1,50 mm	65	12	68
0194600164000	194-16M	1,50, 1,60, 1,70, 1,80, 1,90, 2,00, 2,10, 2,20, 2,30, 2,40, 2,50, 2,60, 2,70, 2,80, 2,90, 3,00 mm	65	12	78

197-...

FEELER GAUGE TAPE

- in plastic box
- length 5 m, width 13 mm
- thickness markings each 10 cm
- spring band steel
- 197-01 and 197-02: stainless steel



Code	Number	Thickness mm	Pieces	Weight/g
0197000014000	197-01	0,01	6	22
0197000024000	197-02	0,02	6	30
0197000034000	197-03	0,03	6	32
0197000044000	197-04	0,04	6	38
0197000054000	197-05	0,05	6	44
0197000064000	197-06	0,06	6	50
0197000074000	197-07	0,07	6	52
0197000084000	197-08	0,08	6	60
0197000104000	197-10	0,10	6	78
0197000154000	197-15	0,15	6	102
0197000204000	197-20	0,20	6	130
0197000254000	197-25	0,25	6	150
0197000304000	197-30	0,30	6	165
0197000404000	197-40	0,40	6	255
0197000504000	197-50	0,50	6	345

8421/8422/8423

RADIUS GAUGE, CONCAVE AND CONVEX

- with locking screw
- special steel



Code	Number	Radius mm	Blade	Pieces	Weight/g
8421000000000	8421	1,0-7	17	6	63
8422000000000	8422	7,5-15	16	6	97,6
8423000000000	8423	15,5-25	15	6	92,7

1580-...

INSIDE CALIPER

- for transferring inside measurements
- polished with riveted hinge
- punched bright steel



Code	Number	l/mm	l/Inch	Pieces	Weight/g
1580002002000	1580-200	200	8	1	114
1580003002000	1580-300	300	12	1	206

1581-...

EXTERNAL CALIPER

- for transferring outside measurements
- polished with riveted hinge
- punched bright steel



Code	Number	l/mm	l/Inch	Pieces	Weight/g
1581002002000	1581-200	200	8	1	142
1581002502000	1581-250	250	10	1	218
1581003002000	1581-300	300	12	1	332
1581005002000	1581-500	500	20	1	968

1584-...

DIVIDER

- drop forged pattern with hardened points
- opening angle 0-180°
- polished with riveted hinge
- special steel



Code	Number	l/mm	l/Inch	Shank cross section approx mm	Pieces	Weight/g
1584001501000	1584-150	150	6	7 x 8	1	143
1584002001000	1584-200	200	8	9 x 10	1	237
1584002501000	1584-250	250	10	9 x 9	1	303
1584003001000	1584-300	300	12	9 x 9	1	380
1584005001000	1584-500	500	20	12 x 12	1	1030

1585-...

BOW DIVIDER

- drop forged pattern with hardened points
- opening angle 0-85°
- standing bow
- polished with riveted hinge
- special steel



Code	Number	l/mm	l/Inch	Pieces	Weight/g
1585001501000	1585-150	150	6	1	179
1585002001000	1585-200	200	8	1	353
1585002501000	1585-250	250	10	1	347
1585003001000	1585-300	300	12	1	445
1585004001000	1585-400	400	16	1	638
1585005001000	1585-500	500	20	1	1021

1586-200

DIVIDER WITH PENCIL HOLDER

- drop forged pattern with hardened points
- opening angle 0-85°
- with standing bow and pencil holder
- polished with riveted hinge
- special steel



Code	Number	l/mm	l/Inch	Pieces	Weight/g
1586002001000	1586-200	200	8	1	265

1587-...

SPRING DIVIDER

- square blade with hardened points
- end-to-end spindle
- special steel

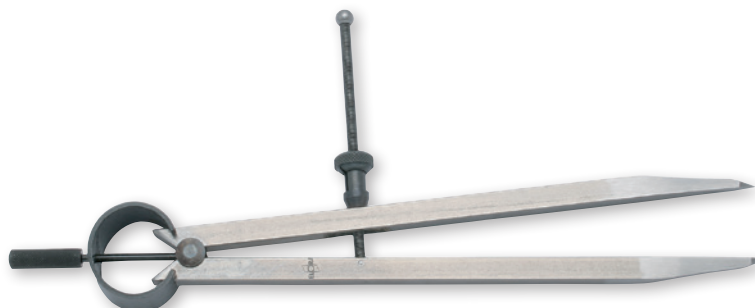

Code	Number	l/mm	l/Inch	Pieces	Weight/g
1587001501000	1587-150	150	6	1	171
1587002001000	1587-200	200	8	1	160
1587002501000	1587-250	250	10	1	267

1590/1590E

ENGINEER'S SCRIBER

- grip gunmetal-finished and knurled
- with interchangeable, screwed steel point
- high grade tool steel



Code	Number	l/mm	l/Inch	Pieces	Weight/g
1590000005100	1590	175	7	12	40
1590400005100	1590E	90	3,5	1	5

1591/1591E

ENGINEER'S SCRIBER

- grip gunmetal-finished and knurled
- with one straight and one angled interchangeable, screwed steel point
- 1591-E80: Spare point straight, 1591-E90: Spare point bent
- high grade tool steel



Code	Number	l/mm	l/Inch	Pieces	Weight/g
1591000005100	1591	250	10	12	50
1591400805100	1591-E80	80	3,2	1	5
1591400905100	1591-E90	80	3,2	1	5

1592

CARBIDE HEXAGON ENGINEER'S SCRIBER

- pattern with hexagonal shaft and deep inserted point
- chrome plated pocket clip
- carbide point



Code	Number	l/mm	l/Inch	Pieces	Weight/g
1592000000000	1592	145	5,8	12	40

1593/1593E

CARBIDE ENGINEER'S SCRIBER

- with interchangeable-, on both sides useable points
- points immersible for protection against damages and risk of injury
- shaft with pocket clip and ribbing surface at the gripping area
- 1593E: Spare point
- carbide point, shaft made of plastic



Code	Number	l/mm	l/Inch	Pieces	Weight/g
1593000000000	1593	150	6	12	35
1593400250000	1593E	25	1	1	5





AUTO- MOTIVE- AND SPECIAL TOOLS

Engine, Oil Service, Exhaust, Clutch _____	Page 426
Brakes, Wheels, Chassis _____	Page 443
Car Bodyworks _____	Page 451
Battery _____	Page 459
Pullers _____	Page 461
Motor Vehicle-Tool Kits _____	Page 470